

ALWAYS
CHOOSE SMART

SMART
DOOR LOCK



Room door smart lock



TECHNICAL PARAMETERS/FUNCTIONS

Product model	0217
Main material	Aluminium alloy
Fingerprint/password/credit card capacity	Total 200
Product color	Electroplating blue&black
Power supply mode	4*AA
Packing specification	1ctn 10PCS
Whole package parameters	0.095m ³
Weight of the whole CTN	24.85kg
Applicable temperature	-25°C-70°C
Applicable door thickness	35-55mm



Fingerprint



Password



Card



Key



Temporary password



Ttlock App (Optional)



Tuya App (Optional)



USB

Electroplating Blue & Black

PRODUCT SIZE

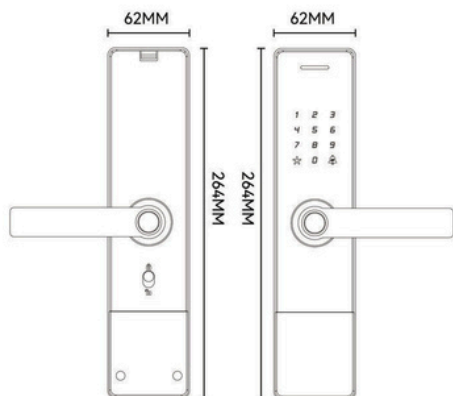

OPTIONAL LOCK BODY



50 series lock body

50 series side strips apply
125mm-200mm



24240/6068
lock body



4085/4585 and
above lock body



4558 lock body



72 series lock body

Room door smart lock



Face

Basic



Black

TECHNICAL PARAMETERS/FUNCTIONS

Product model	0218
Main material	Aluminium alloy
Fingerprint/password/credit card capacity	Total 200
Face capacity	50
Product color	Black
Power supply mode	4*AA/2500mAH
Packing specification	1ctn 10PCS
Whole package parameters	0.095m ³
Weight of the whole CTN	22.6kg
Applicable temperature	-25°C-70°C
Applicable door thickness	35-55mm



Face Unlocking
(Optional)



Fingerprint



Password



Card



Key



Temporary
password



Tuya App



USB



Camera
(Optional)

PRODUCT SIZE

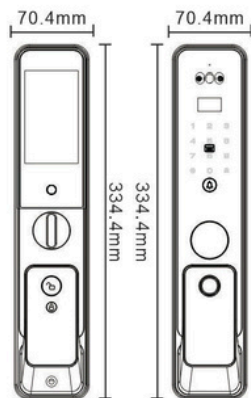

OPTIONAL LOCK BODY



50 series lock body

50 series side strips apply
125mm-200mm



24240/6068
lock body



4085/4585 and
above lock body



4558 lock body



72 series lock body

Fully automatic 3D face smart lock



TECHNICAL PARAMETERS/FUNCTIONS

Product model	0108
Main material	Aluminium alloy
Fingerprint/password/credit card capacity	Total 200
Face capacity	50
Product color	Black
Power supply mode	4200mAH
Packing specification	1ctn 5PCS
Whole package parameters	0.059m ³
Weight of the whole CTN	23.3kg
Applicable temperature	-25°C-70°C
Applicable door thickness	40-120mm

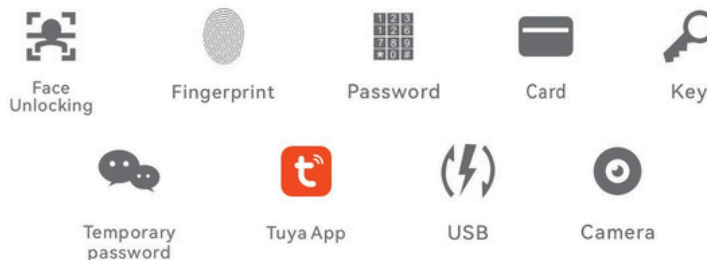

Black

PRODUCT SIZE

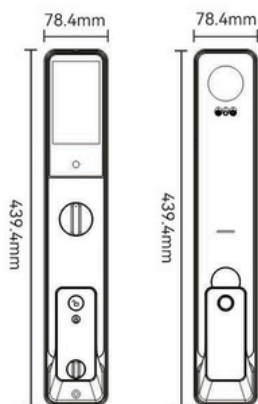

OPTIONAL LOCK BODY

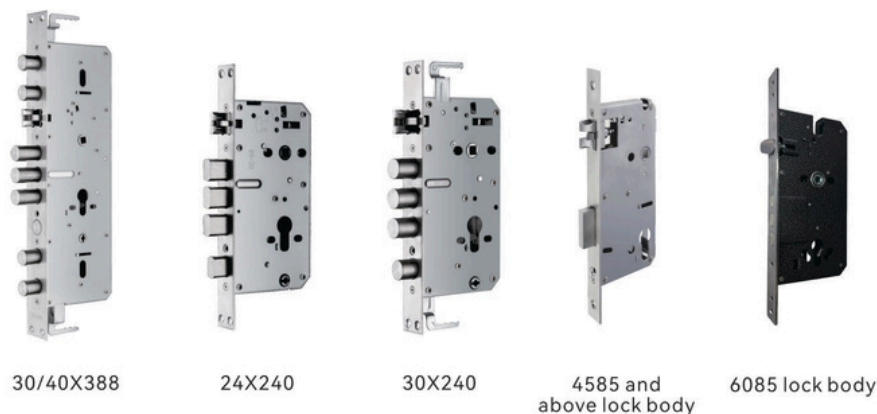

Fully automatic 3D face smart lock



TECHNICAL PARAMETERS/FUNCTIONS

Product model	0117
Main material	Aluminium alloy
Fingerprint/password/credit card capacity	Total 200
Face capacity	50
Product color	Iron Gray
Power supply mode	4200mah
Packing specification	1ctn 5PCS
Whole package parameters	0.059m³
Weight of the whole CTN	25.45kg
Applicable temperature	-25°C-70°C
Applicable door thickness	40-120mm



Face
Unlocking



Fingerprint



Password



Card



Key



Temporary
password



Palm Vein



Tuya App



USB



Camera

Iron Gray

PRODUCT SIZE

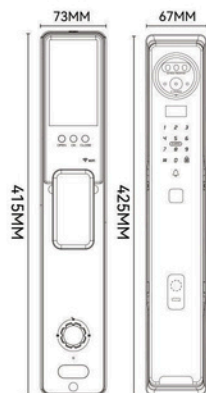

OPTIONAL LOCK BODY



30/40X388

24X240

30X240

4585 and
above lock body

6085 lock body

5572 lock body

Israeli Lock Body

3D face smart lock



Product model	0118
Main material	Aluminium alloy
Fingerprint/password/credit card capacity	Total 200
Face capacity	50
Product color	Iron Gray
Power supply mode	4200mah
Packing specification	1ctn 5PCS
Whole package parameters	0.059m ³
Weight of the whole CTN	27.2kg
Applicable temperature	-25°C-70°C
Applicable door thickness	40-120mm



Face Unlocking



Fingerprint



Password



Card



Key



Temporary password



Palm Vein



Tuya App



USB



Camera

Iron Gray

PRODUCT SIZE

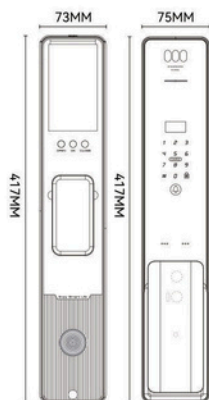

OPTIONAL LOCK BODY



30/40X388

24X240

30X240

4585 and above lock body

6085 lock body

5572 lock body

Israeli Lock Body

Fully automatic 3D face smart lock



Iron Gray

PRODUCT SIZE

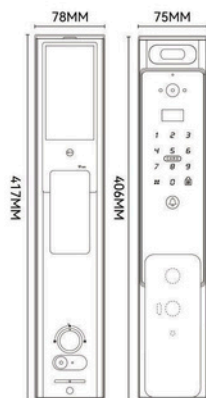

TECHNICAL PARAMETERS/FUNCTIONS

Product model	0119
Main material	Aluminium alloy
Fingerprint/password/credit card capacity	Total 200
Face capacity	50
Product color	Iron Gray
Power supply mode	4200mah
Packing specification	1ctn 5PCS
Whole package parameters	0.059m ³
Weight of the whole CTN	27.7kg
Applicable temperature	-25°C-70°C
Applicable door thickness	40-120mm

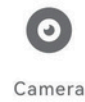
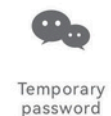

OPTIONAL LOCK BODY

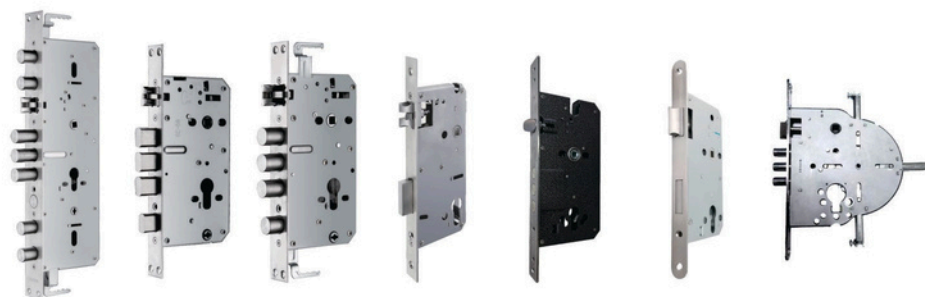

30/40X388

24X240

30X240

4585 and
above lock body

6085 lock body

5572 lock body

Israeli Lock Body

Room door smart lock



TECHNICAL PARAMETERS/FUNCTIONS

Product model	0204
Main material	Alloy steel
Fingerprint/password/credit card capacity	Total 200
Product color	Black
Power supply mode	4*AA
Packing specification	1ctn 10PCS
Whole package parameters	0.095m ³
Weight of the whole CTN	23.85kg
Applicable temperature	-25°C-70°C
Applicable door thickness	35-55mm



Fingerprint



Password



Card



Key



Temporary password



Ttlock App (Optional)



Tuya App (Optional)



USB

Black

PRODUCT SIZE

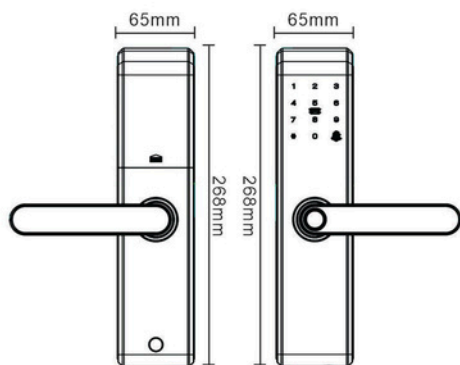

OPTIONAL LOCK BODY



50 series lock body

50 series side strips apply 125mm-200mm



24240/6068 lock body



4085/4585 and above lock body



4558 lock body



72 series lock body

Room door smart lock



Facial style



Basics



Camera

Black
 Glod
 Bronze

TECHNICAL PARAMETERS/FUNCTIONS

Product model	0205
Main material	Aluminium alloy
Fingerprint/password/credit card capacity	Total 200
Face capacity	50
Product color	Black
Power supply mode	4*AA
Facial cat eye power supply	2500mAH
Packing specification	1ctn 10PCS
Whole package parameters	0.095m ³
Weight of the whole CTN	22.6kg
Applicable temperature	-25°C-70°C
Applicable door thickness	35-55mm

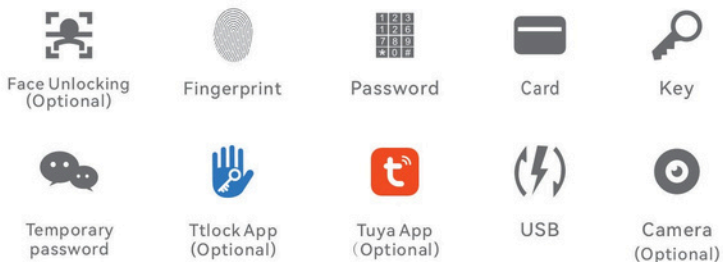

PRODUCT SIZE

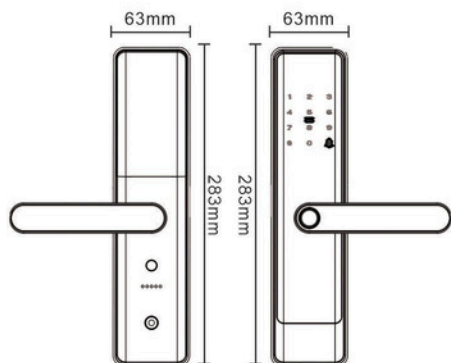

OPTIONAL LOCK BODY



Room door smart lock



TECHNICAL PARAMETERS/FUNCTIONS

Product model	0210
Main material	Aluminium alloy
Fingerprint/password/credit card capacity	Total 1270
Product color	Black
Power supply mode	4*AA
Packing specification	1ctn 10PCS
Whole packageparameters	0.065m ³
Weight of the wholeCTN	14.69kg
Applicable temperature	-25°C-70°C
Applicable door thickness	35-55mm



Fingerprint



Password



Card



Key



Temporary password



Ttlock App (Optional)



Tuya App (Optional)



USB

Black

PRODUCT SIZE

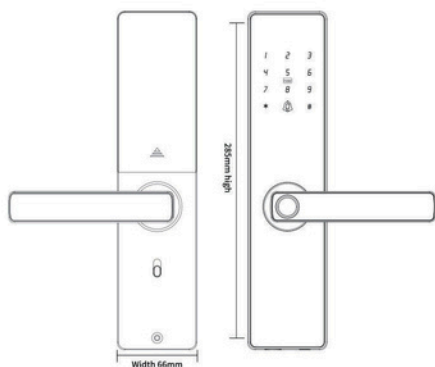

OPTIONAL LOCK BODY



50 series lock body

50 series side strips apply 125mm-200mm



24240/6068 lock body



4085/4585 and above lock body



4558 lock body



72 series lock body

Room door smart lock



Matte black
 Glossy Black
 White
 Gray

TECHNICAL PARAMETERS/FUNCTIONS

Product model	0219
Main material	Aluminium alloy
Fingerprint/password/credit card capacity	Total 200
Face capacity	50
Product color	Black/Glossy Black/White/Grey
Power supply mode	4*AA
Facial cat eye power supply	2500mAH
Packing specification	1ctn 10PCS
Whole package parameters	0.095m ³
Weight of the whole CTN	22.6kg
Applicable temperature	-25°C-70°C
Applicable door thickness	35-55mm

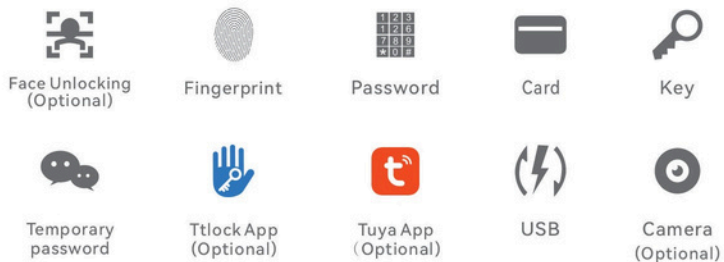

PRODUCT SIZE

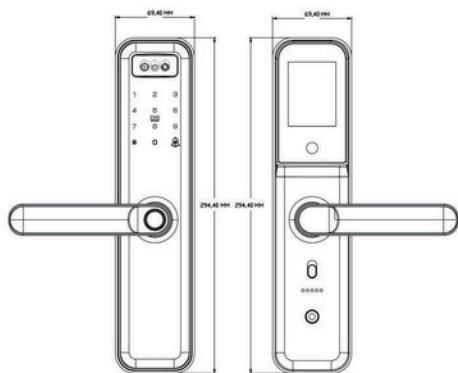

OPTIONAL LOCK BODY



50 series lock body
 50 series side strips apply 125mm-200mm
 24240/6068 lock body
 4085/4585 and above lock body
 4558 lock body
 72 series lock body

Room door smart lock



Easy installation, perfect replacement

Black

PRODUCT SIZE

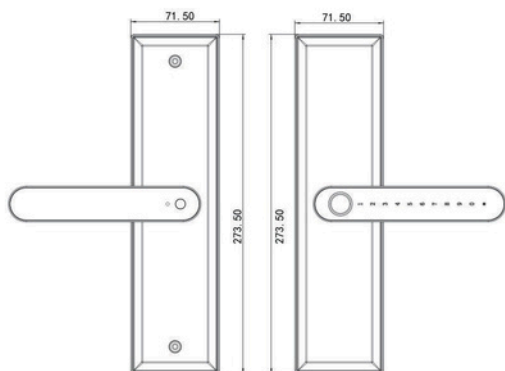

TECHNICAL PARAMETERS/FUNCTIONS

Product model	0220
Main material	Aluminium alloy
Fingerprint/password/credit card capacity	Total 200
Product color	Black
Power supply mode	4*AAA
Packing specification	1ctn 10PCS
Whole package parameters	0.088m ³
Weight of the whole CTN	15kg
Applicable temperature	-25°C-70°C
Applicable door thickness	35-65mm

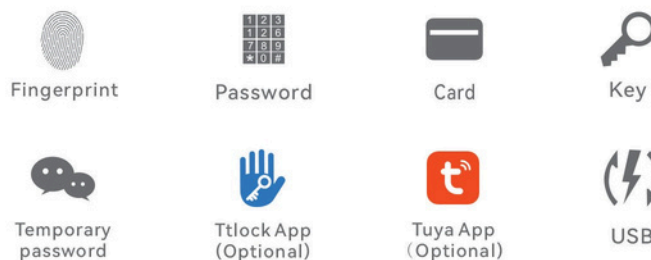

OPTIONAL LOCK BODY



50 series lock body
50 series side strips apply
125mm-200mm

24240/6068
lock body

4085/4585 and
above lock body

4558 lock body

72 series lock body

Room door smart lock



Black
 Stone slab
 Golden

TECHNICAL PARAMETERS/FUNCTIONS

Product model	0221
Main material	Aluminium alloy
Fingerprint/password/credit card capacity	Total 200
Face capacity	50
Product color	Black/Stone slab/Golden
Power supply mode	4*AA
Facial cat eye power supply	2500mAH
Packing specification	1ctn 10PCS
Whole package parameters	0.095m ³
Weight of the whole CTN	24.85kg
Applicable temperature	-25°C-70°C
Applicable door thickness	35-55mm

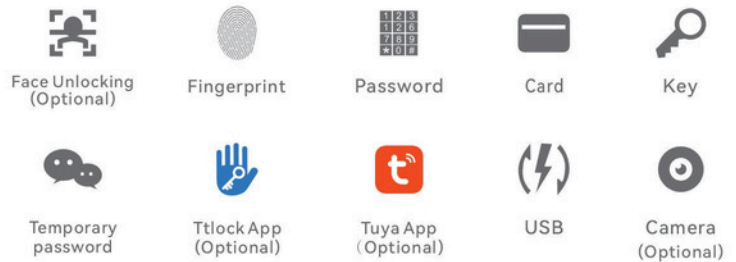

PRODUCT SIZE

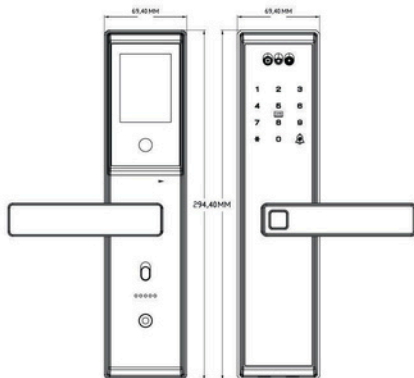

OPTIONAL LOCK BODY



Room door smart lock



TECHNICAL PARAMETERS/FUNCTIONS

Product model	0223
Main material	Aluminium alloy
Fingerprint/password/credit card capacity	Total 100
Product color	Black/Grey
Power supply mode	4*AA
Packing specification	1ctn 10PCS
Whole package parameters	0.095m ³
Weight of the whole CTN	22.85kg
Applicable temperature	-25°C-70°C
Applicable door thickness	35-55mm



Fingerprint



Password



Card



Key



Temporary password



Tlock App (Optional)



Tuya App (Optional)



USB

Black Gray

PRODUCT SIZE

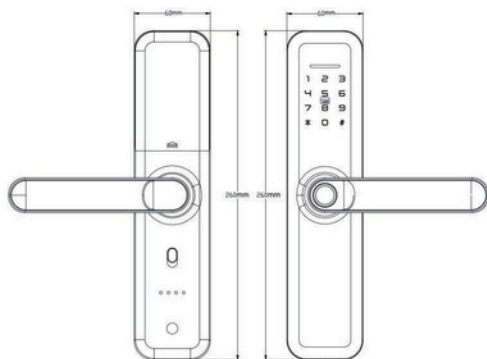

OPTIONAL LOCK BODY



50 series lock body

50 series side strips apply 125mm-200mm



24240/6068 lock body



4085/4585 and above lock body



4558 lock body



72 series lock body



12-01

Fully automatic 3D face smart lock



Black
 Black Gold

PRODUCT SIZE

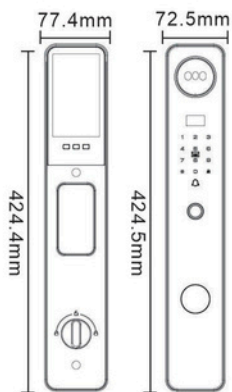

TECHNICAL PARAMETERS/FUNCTIONS

Product model	0109
Main material	Alloy steel
Fingerprint/password/credit card capacity	Total 200
Face capacity	50
Product color	Black
Power supply mode	4200mAH
Packing specification	1ctn 5PCS
Whole package parameters	0.059m ³
Weight of the whole CTN	23.3kg
Applicable temperature	-25°C-70°C
Applicable door thickness	40-120mm

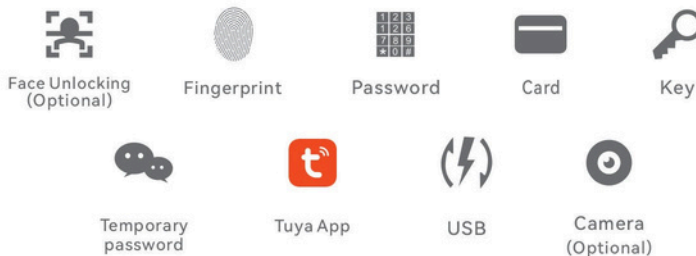

OPTIONAL LOCK BODY



Fully automatic 3D face smart lock



 Gun grey

PRODUCT SIZE

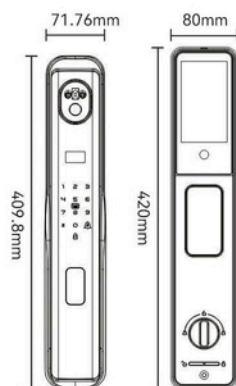

TECHNICAL PARAMETERS/FUNCTIONS

Product model	0110
Main material	Aluminium alloy
Fingerprint/password/credit card capacity	Total 200
Face capacity	50
Product color	Gun grey
Power supply mode	4200mAH
Packing specification	1ctn 5PCS
Whole package parameters	0.059m ³
Weight of the whole CTN	22.19kg
Applicable temperature	-25°C-70°C
Applicable door thickness	40-120mm

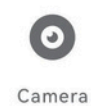
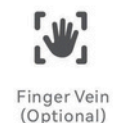
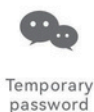

OPTIONAL LOCK BODY



30/40X388

24X240

30X240

4585 and

6085 lock body

5572 lock body

Israeli Lock Body

Fully automatic 3D face smart lock



Gray

PRODUCT SIZE

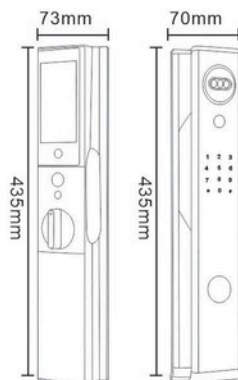

TECHNICAL PARAMETERS/FUNCTIONS

Product model	0111
Main material	Aluminium alloy
Fingerprint/password/credit card capacity	Total 200
Face capacity	50
Product color	Gray
Power supply mode	4200mAh+4200mAhhhh
Packing specification	1ctn 5PCS
Whole packageparameters	0.059m³
Weight of the wholeCTN	26kg
Applicable temperature	-25°C-70°C
Applicable door thickness	40-120mm

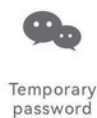

OPTIONAL LOCK BODY



30/40X388

24X240

30X240

4585 and
above lock body

6085 lock body

5572 lock body

Israeli Lock Body

Fully automatic 3D face smart lock



 Black

PRODUCT SIZE

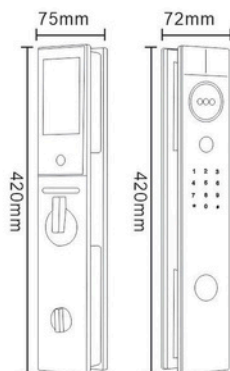

TECHNICAL PARAMETERS/FUNCTIONS

Product model	0113
Main material	Aluminium alloy
Fingerprint/password/credit card capacity	Total 200
Face capacity	50
Product color	Black
Power supply mode	4200+2500mAH
Packing specification	1ctn 5PCS
Whole package parameters	0.059m ³
Weight of the whole CTN	25.8kg
Applicable temperature	-25°C-70°C
Applicable door thickness	40-120mm



Face
Unlocking



Fingerprint



Password



Card



Key



Temporary
password



Tuya App



USB



Camera

OPTIONAL LOCK BODY



30/40X388



24X240



30X240



4585 and
above lock body



6085 lock body

Fully automatic 3D face smart lock



Mocha brown
 Grey

TECHNICAL PARAMETERS/FUNCTIONS

Product model	0114
Main material	Aluminium alloy
Fingerprint/password/credit card capacity	Total 200
Face capacity	50
Product color	Mocha brown/grey
Power supply mode	5000mAh
Packing specification	1ctn 5PCS
Whole package parameters	0.059m ³
Weight of the whole CTN	26.25kg
Applicable temperature	-25°C-70°C
Applicable door thickness	40-120mm

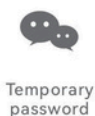

PRODUCT SIZE

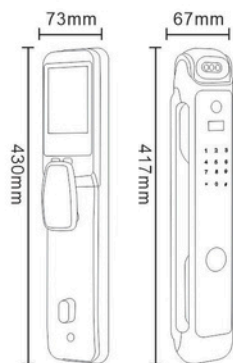

OPTIONAL LOCK BODY



30/40X388



24X240



30X240



4585 and
above lock body



6085 lock body

Fully automatic 3D face smart lock



Rose gold Snow grey

PRODUCT SIZE

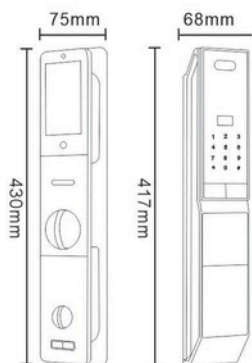

TECHNICAL PARAMETERS/FUNCTIONS

Product model	0116
Main material	Aluminium alloy
Fingerprint/password/credit card capacity	Total 200
Face capacity	50
Product color	Rose gold/Snow grey
Power supply mode	4200+2500(mAH)
Packing specification	1ctn 5PCS
Whole packageparameters	0.059m ³
Weight of the wholeCTN	23.5kg
Applicable temperature	-25°C-70°C
Applicable door thickness	40-120mm



Face
Unlocking



Fingerprint



Password



Card



Key



Temporary
password



Tuya App



USB



Camera

OPTIONAL LOCK BODY



30/40X388



24X240



30X240

Fully automatic 3D face smart lock

 Exclusive for
 TongTong



 黑色
 Black

TECHNICAL PARAMETERS/FUNCTIONS

Product model	0120
Main material	Aluminium alloy
Fingerprint/password/credit card capacity	Total 1300
Face capacity	100
Product color	Black
Power supply mode	4200mAh
Packing specification	1ctn 5PCS
Whole package parameters	0.059m ³
Weight of the whole CTN	26kg
Applicable temperature	-25°C-70°C
Applicable door thickness	40-120mm



Face
Unlocking



Fingerprint



Password



Card



Key



Temporary
password



Palm Vein



USB



Camera

PRODUCT SIZE

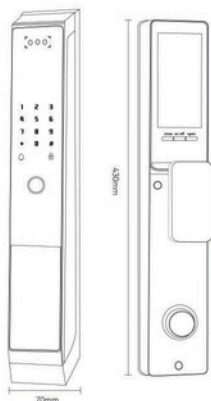

OPTIONAL LOCK BODY



30/40X388



24X240



30X240



85 lock body



6085 lock body

Fully automatic 3D face smart lock



Black
 Mocha Brown

TECHNICAL PARAMETERS/FUNCTIONS

Product model	0123
Main material	Aluminium alloy
Fingerprint/password/credit card capacity	Total 200
Face capacity	50
Product color	Black/Mocha brown
Power supply mode	4200mAH
Packing specification	1ctn 5PCS
Whole package parameters	0.059m ³
Weight of the whole CTN	23.6kg
Applicable temperature	-25°C-70°C
Applicable door thickness	40-120mm



Face
Unlocking



Fingerprint



Password



Card



Key



Temporary
password



Tuya App



USB



Camera

PRODUCT SIZE

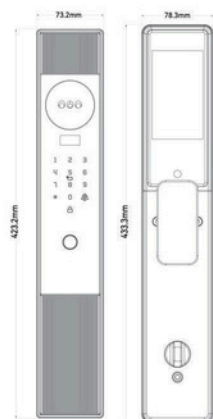

OPTIONAL LOCK BODY



30/40X388



24X240



30X240



4585 and
above lock body



6085 Lock body

Fully automatic 3D face smart lock



Black
 Mocha Brown

TECHNICAL PARAMETERS/FUNCTIONS

Product model	0124
Main material	Aluminium alloy
Fingerprint/password/credit card capacity	Total 200
Face capacity	50
Product color	Black/Mocha brown
Power supply mode	4200mAH
Packing specification	1ctn 5PCS
Whole package parameters	0.059m ³
Weight of the whole CTN	24.1kg
Applicable temperature	-25°C-70°C
Applicable door thickness	40-120mm

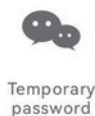

PRODUCT SIZE

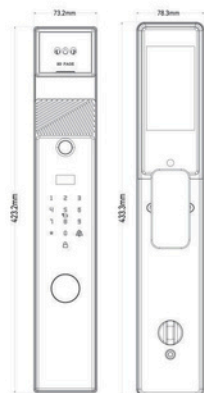

OPTIONAL LOCK BODY



30/40X388



24X240



30X240



4585 and
above lock body



6085 Lock body

Fully automatic 3D face smart lock



Black

TECHNICAL PARAMETERS/FUNCTIONS

Product model	9004
Main material	Aluminium alloy
Fingerprint/password/credit card capacity	Total 200
Face capacity	50
Product color	Black
Power supply mode	4200mAh
Packing specification	1ctn 5PCS
Whole package parameters	0.059m ³
Weight of the whole CTN	23kg
Applicable temperature	-25°C-70°C
Applicable door thickness	40-120mm



Face
Unlocking



Fingerprint



Password



Card



Key



Temporary
password



Tuya App



USB



Camera

PRODUCT SIZE

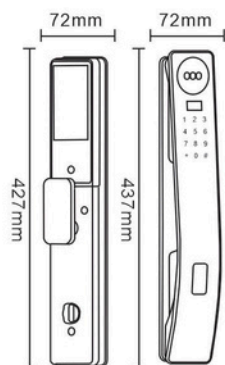

OPTIONAL LOCK BODY



30/40X388



24X240



30X240



4585 and
above lock body



6085 Lock body

Fully automatic 3D face smart lock



Basic model

Black

TECHNICAL PARAMETERS/FUNCTIONS

Product model	9005
Main material	Aluminium alloy
Fingerprint/password/credit card capacity	Total 200
Face capacity	50
Product color	Black
Power supply mode	4200mAH
Packing specification	1ctn 5PCS
Whole package parameters	0.059m ³
Weight of the whole CTN	19.22kg
Applicable temperature	-25°C-70°C
Applicable door thickness	40-120mm

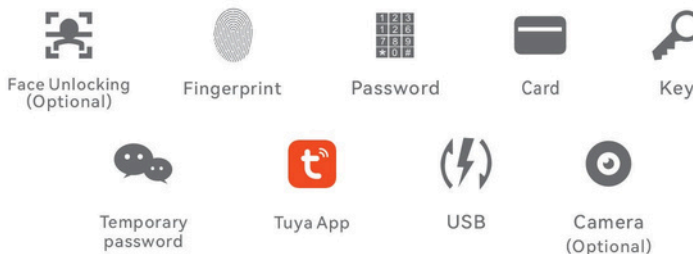

PRODUCT SIZE

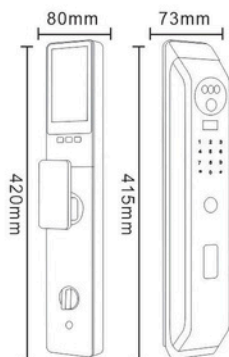

OPTIONAL LOCK BODY



Fully automatic 3D face smart lock



KKK/29

Black Black gold

PRODUCT SIZE

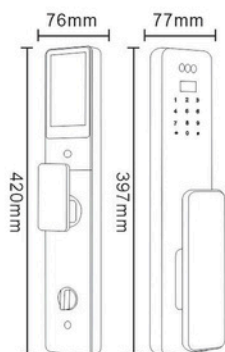

TECHNICAL PARAMETERS/FUNCTIONS

Product model	9006
Main material	Aluminium alloy
Fingerprint/password/credit card capacity	Total 200
Face capacity	50
Product color	Black/black gold
Power supply mode	4200mAh
Packing specification	1ctn 5PCS
Whole package parameters	0.059m ³
Weight of the whole CTN	23.5kg
Applicable temperature	-25°C-70°C
Applicable door thickness	40-120mm



Card

Key



Temporary password

Tuya App

USB

Camera

OPTIONAL LOCK BODY



30/40X388

24X240

30X240

85 lock body

4585 and above lock body

5572 lock body

Israeli Lock Body

Optional Israeli lock body

Fully automatic 3D face smart lock

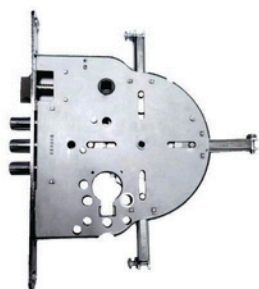

Israeli Lock Body



Black Black gold

TECHNICAL PARAMETERS/FUNCTIONS

Product model	9007
Main material	Aluminium alloy
Fingerprint/password/credit card capacity	Total 200
Face capacity	50
Product color	Black/black gold
Power supply mode	4200mAh
Packing specification	1ctn 5PCS
Whole package parameters	0.059m ³
Weight of the whole CTN	25.05kg
Applicable temperature	-25°C-70°C
Applicable door thickness	40-120mm

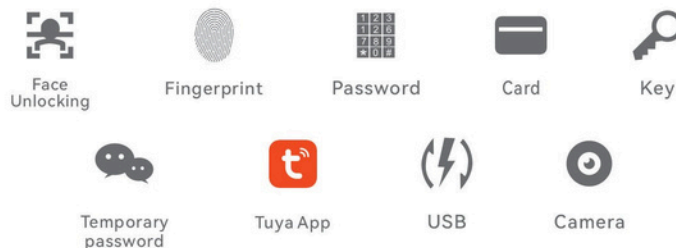

PRODUCT SIZE

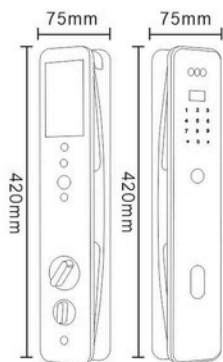

OPTIONAL LOCK BODY

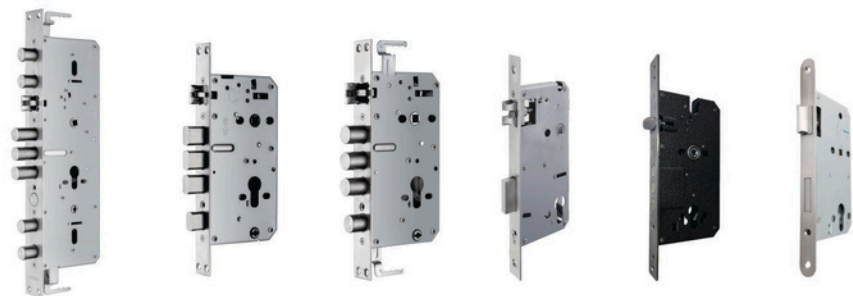

30/40X388

24X240

30X240

4585 and above lock body

6085 lock body

5572 lock body

Fully automatic smart lock



Red Bronze
 Black Bronze
 Golden Bronze

PRODUCT SIZE

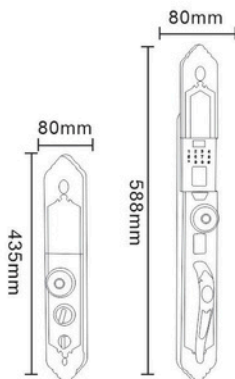

TECHNICAL PARAMETERS/FUNCTIONS

Product model	9008
Main material	Aluminium alloy
Fingerprint/password/credit card capacity	Total 200
Face capacity	50
Product color	Red bronze/Black bronze/Golden bronze
Power supply mode	4200mAh
Packing specification	1ctn 2PCS
Whole package parameters	0.063m ³
Weight of the whole CTN	16kg
Applicable temperature	-25°C-70°C
Applicable door thickness	40-120mm

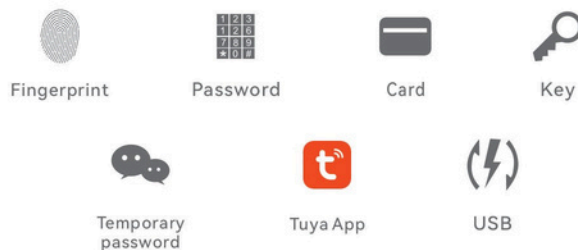

OPTIONAL LOCK BODY



30/40X388



24X240



30X240

Semi-automatic smartlockh



TECHNICAL PARAMETERS/FUNCTIONS

Product model	0101B
Main material	Aluminium alloy
Fingerprint/password/credit card capacity	Total 200
Product color	Black
Power supply mode	4*AA
Packing specification	1ctn 5PCS
Whole packageparameters	0.059m ³
Weight of the wholeCTN	21.34kg
Applicable temperature	-25°C-70°C
Applicable door thickness	40-120mm



Fingerprint



Password



Card



Key



Temporary password



Tlock App (Optional)



Tuya App (Optional)



USB

Black

PRODUCT SIZE

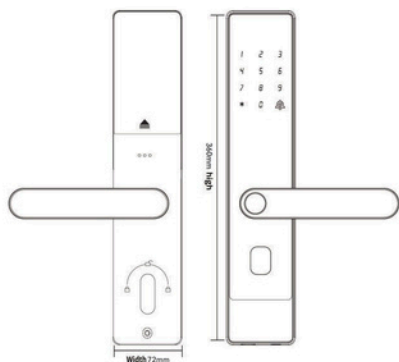

OPTIONAL LOCK BODY



30/40X388



24X240



30X240

Semi-automatic smartlockh



 Black

PRODUCT SIZE

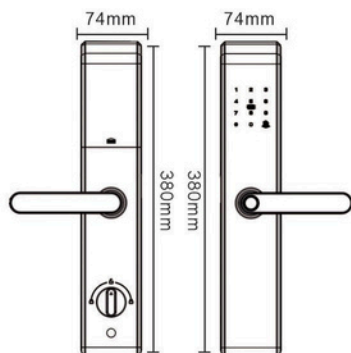

TECHNICAL PARAMETERS/FUNCTIONS

Product model	0102
Main material	Alloy steel
Fingerprint/password/credit card capacity	Total 200
Product color	Black
Power supply mode	4*AA
Packing specification	1ctn 5PCS
Whole packageparameters	0.063m ³
Weight of the wholeCTN	21.34kg
Applicable temperature	-25°C-70°C
Applicable door thickness	40-120mm

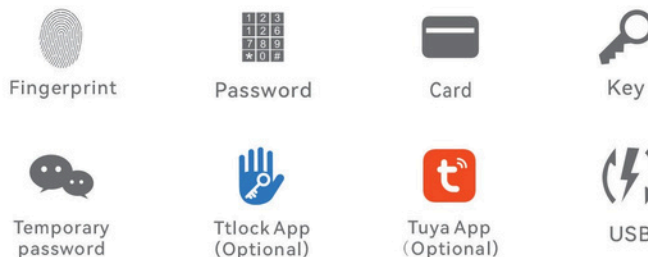

OPTIONAL LOCK BODY



Semi-automatic smartlockh



Basics



Facial style

Camera

Black Sky grey

TECHNICAL PARAMETERS/FUNCTIONS

Product model	0104
Main material	Aluminium alloy
Fingerprint/password/credit card capacity	Total 200
Face capacity	50
Product color	Black/Sky grey
Power supply mode	4*AA
Facial cat eye power supply	3200mAh
Packing specification	1ctn 5PCS
Whole packageparameters	0.059m ³
Weight of the wholeCTN	18.65kg
Applicable temperature	-25°C-70°C
Applicable door thickness	40-120mm



PRODUCT SIZE

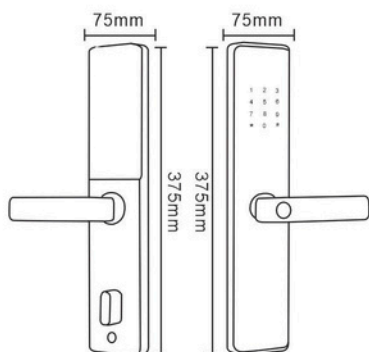

OPTIONAL LOCK BODY

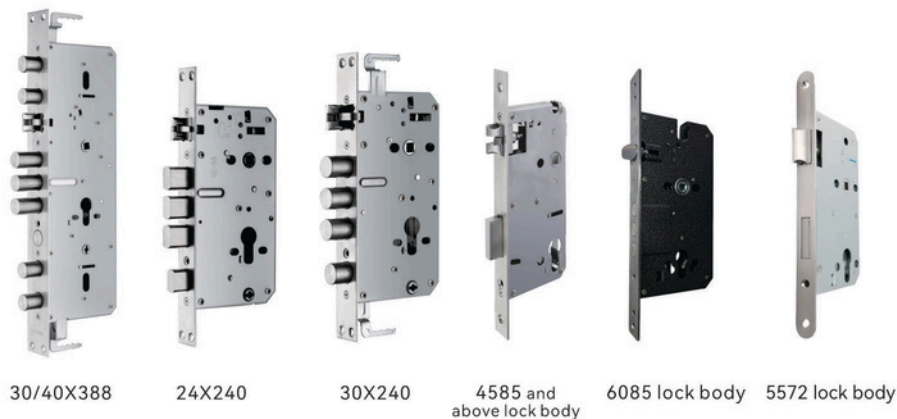

Semi-automatic smartlockh



TECHNICAL PARAMETERS/FUNCTIONS

Product model	0107
Main material	Aluminium alloy
Fingerprint/password/credit card capacity	Total 200
Product color	Black rose gold
Power supply mode	8*AA
Packing specification	1ctn 5PCS
Whole packageparameters	0.059m ³
Weight of the wholeCTN	19.5kg
Applicable temperature	-25°C-70°C
Applicable door thickness	40-120mm



Fingerprint



Password



Card



Key



Temporary password



Ttlock App (Optional)



Tuya App (Optional)



USB

 Black Rose Gold

PRODUCT SIZE

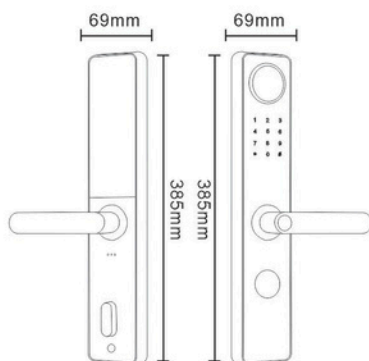

OPTIONAL LOCK BODY



30/40X388



24X240



30X240

Semi-automatic smartlockh



Black

TECHNICAL PARAMETERS/FUNCTIONS

Product model	0122
Main material	Aluminium alloy
Fingerprint/password/credit card capacity	Total 1270
Product color	Black
Power supply mode	8*AA
Packing specification	1ctn 5PCS
Whole packageparameters	0.048m ³
Weight of the wholeCTN	20.12kg
Applicable temperature	-25°C-70°C
Applicable door thickness	40-120mm

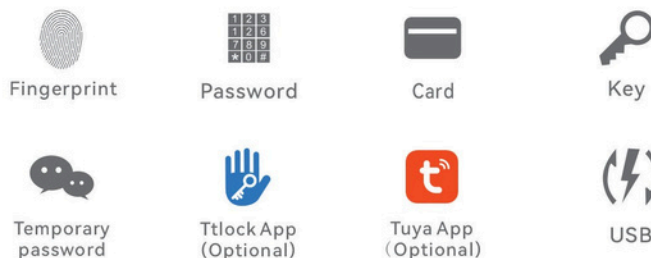

PRODUCT SIZE

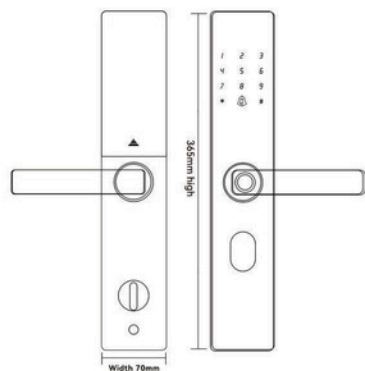

OPTIONAL LOCK BODY



Semi-automatic smartlockh



TECHNICAL PARAMETERS/FUNCTIONS

Product model	0125
Main material	Alloy Steel
Fingerprint/password/credit card capacity	Total 1000
Product color	Black
Power supply mode	4*AA
Packing specification	1ctn 5PCS
Whole packageparameters	0.059m ³
Weight of the wholeCTN	18.1kg
Applicable temperature	-25°C-70°C
Applicable door thickness	40-120mm



Fingerprint



Password



Card



Key



Temporary password



Ttlock App (Optional)



Tuya App (Optional)



USB

Black

PRODUCT SIZE

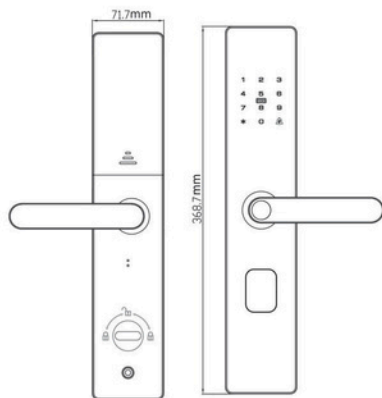

OPTIONAL LOCK BODY



Atresia



Matte black
 Nickel wire drawing

PRODUCT SIZE

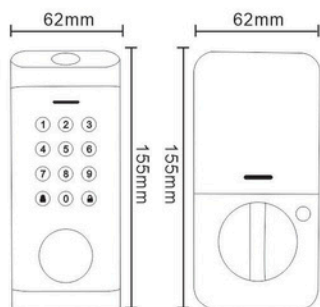

TECHNICAL PARAMETERS/FUNCTIONS

Product model	0304
Main material	Aluminium alloy
Fingerprint/password/card capacity	Total 1250
Product color	Matte black/Nickel wire drawing
Power supply mode	4*AA
Packing specification	1ctn 10PCS
Whole package parameters	0.071m ³
Weight of the whole CTN	13.5kg
Applicable temperature	-25°C-70°C
Applicable door thickness	35-65mm

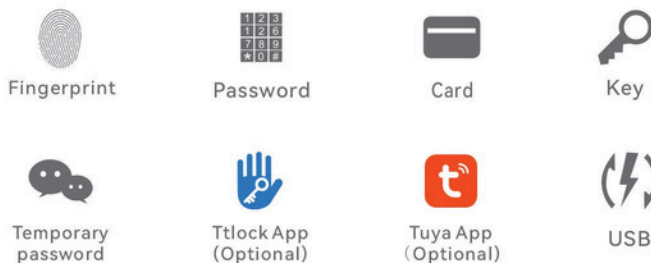

OPTIONAL LOCK BODY

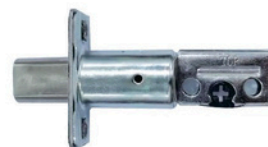

Dumb lock body

Atresia



Matte black
 Nickel wire drawing

PRODUCT SIZE

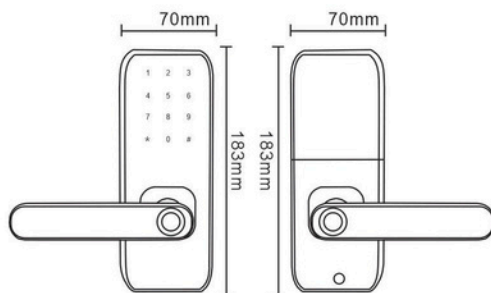

TECHNICAL PARAMETERS/FUNCTIONS

Product model	0403
Main material	Aluminium alloy
Fingerprint/password/card capacity	Total 1250
Product color	Matte black/Nickel wire drawing
Power supply mode	4*AA
Packing specification	1ctn 10PCS
Whole package parameters	0.071m ³
Weight of the whole CTN	17.5kg
Applicable temperature	-25°C-70°C
Applicable door thickness	35-65mm

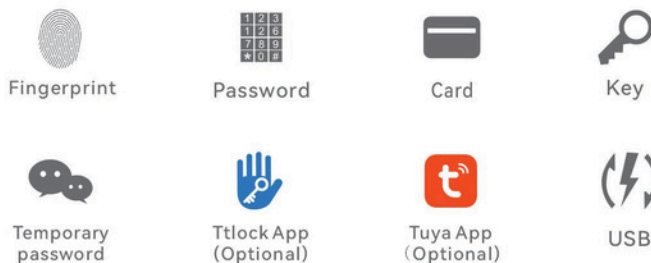

OPTIONAL LOCK BODY



Single Tongue Lock Body

Atresia



Black
 Silver

PRODUCT SIZE

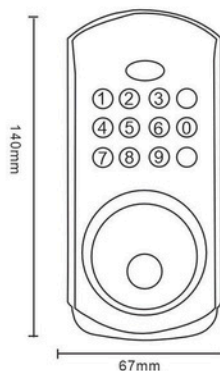

TECHNICAL PARAMETERS/FUNCTIONS

Product model	9201
Main material	Aluminium alloy
password capacity	100
Product color	Black/silver
Power supply mode	4* AA
Packing specification	1ctn 18PCS
Whole package parameters	0.046m ³
Weight of the whole CTN	15.4kg
Applicable temperature	-25°C-70°C
Applicable door thickness	35-65mm



Password



Temporary password



Key



Ttlock App (Optional)



Tuya App (Optional)



USB

OPTIONAL LOCK BODY



Dumb lock body

Atresia



Black
 Silver

PRODUCT SIZE

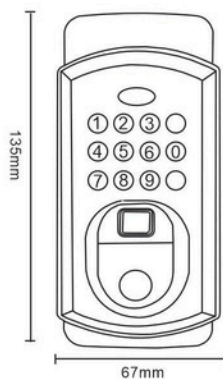

TECHNICAL PARAMETERS/FUNCTIONS

Product model	9202
Main material	Aluminium alloy
Fingerprint/password/card capacity	Total 200
Product color	Black/silver
Power supply mode	4*AA
Packing specification	1ctn 18PCS
Whole package parameters	0.046m ³
Weight of the whole CTN	15.4kg
Applicable temperature	-25°C-70°C
Applicable door thickness	35-65mm



Fingerprint



Password



Key



Temporary password



Ttlock App (Optional)



Tuya App (Optional)



USB

OPTIONAL LOCK BODY

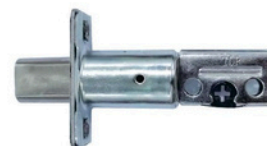

Dumb lock body

Indoor smart ballock



Black
 Silver

PRODUCT SIZE

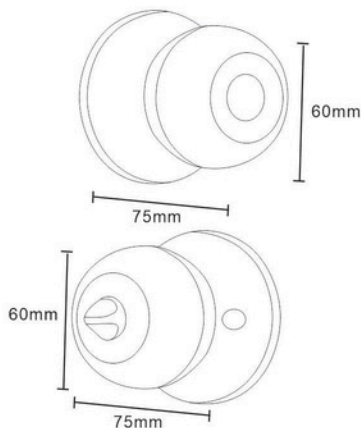

TECHNICAL PARAMETERS/FUNCTIONS

Product model	0502
Main material	Aluminum alloy + Stainless steel
Fingerprint capacity	100 pieces
Product color	Black/Silver
Power supply mode	Ternary lithium battery
Packing specification	1ctn 30PCS
Whole package parameters	0.080m ³
Weight of the whole CTN	21.8kg
Applicable temperature	-10°C-60°C
Applicable door thickness	35-55mm



Fingerprint



Bluetooth



Key



Tuya App
(Optional)



USB

OPTIONAL LOCK BODY



Single Tongue Lock Body

Indoor smart ballock



PRODUCT SIZE

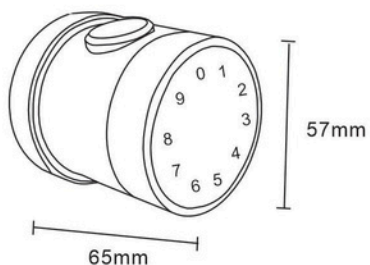

TECHNICAL PARAMETERS/FUNCTIONS

Product model	0507
Main material	Aluminum alloy
Cryptographic capacity	100 groups
Product color	Black/silver/gold/brown/gray
Power supply mode	4*AAA
Packing specification	1ctn 12PCS
Whole package parameters	0.056m ³
Weight of the whole CTN	11.76kg
Applicable temperature	-25°C-65°C
Applicable door thickness	35-55mm



Fingerprint



Password



Key



APP unlock



Tlock App
(Optional)



Tuya App
(Optional)



USB



Bluetooth

OPTIONAL LOCK BODY



Single Tongue Lock Body

Indoor smart ballock



Black
 Silver

PRODUCT SIZE

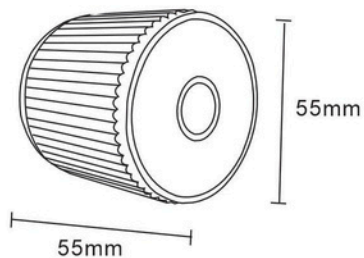

TECHNICAL PARAMETERS/FUNCTIONS

Product model	0508
Main material	Al-mg alloy
Cryptographic capacity	Tota1 200
Product color	Black/Silver
Power supply mode	Built-in lithium battery
Packing specification	1ctn 12PCS
Whole packageparameters	0.056m ³
Weight of the wholeCTN	11.28kg
Applicable temperature	-25°C-65°C
Applicable door thickness	35-85mm



Fingerprint



Password



Key



Ttlock App
(Optional)



Tuya App
(Optional)



USB



Bluetooth

OPTIONAL LOCK BODY



Single Tongue Lock Body



Interior door handle lock



TECHNICAL PARAMETERS/FUNCTIONS

Product model	0604
Main material	Aluminium alloy
Cryptographic capacity	Total 100
Product color	Black/silver/brown/gold/gray
Power supply mode	4*AAA
Packing specification	1ctn 12PCS
Whole package parameters	0.056m ³
Weight of the whole CTN	11.4kg
Applicable temperature	-20°C-65°C
Applicable door thickness	35-65mm



Fingerprint



Password



Card



Key



Temporary password



Ttlock App (Optional)



Tuya App (Optional)



USB

PRODUCT SIZE

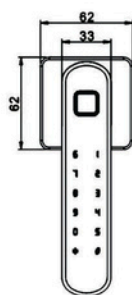
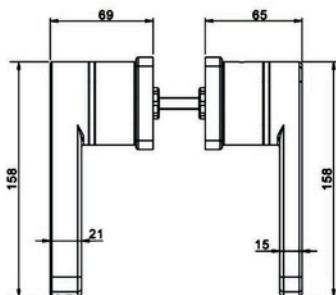

OPTIONAL LOCK BODY



Single Tongue Lock Body



50 series lock body

50 series side strips apply 125mm-200mm



72 series lock body



85 lock body



4558 lock body

Interior door handle lock



PRODUCT SIZE

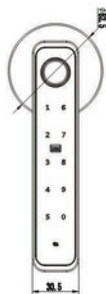
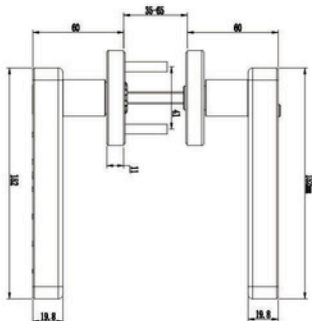

TECHNICAL PARAMETERS/FUNCTIONS

Product model	0605
Main material	Aluminium alloy
Cryptographic capacity	Total 200
Product color	Black/silver/grey/Champagne gold/coffee
Power supply mode	4*AAA
Packing specification	1ctn 12PCS
Whole package parameters	0.056m ³
Weight of the whole CTN	11.4kg
Applicable temperature	-20°C-65°C
Applicable door thickness	35-65mm

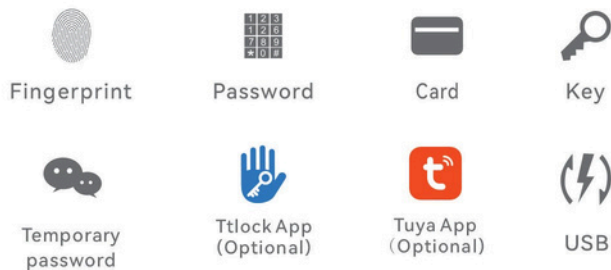

OPTIONAL LOCK BODY



Interior door handle lock



TECHNICAL PARAMETERS/FUNCTIONS

Product model	9401
Main material	Aluminium alloy
Cryptographic capacity	Total 200
Product color	Black/silver
Power supply mode	4*AAA
Packing specification	1ctn 20PCS
Whole package parameters	0.069m ³
Weight of the whole CTN	15kg
Applicable temperature	-25°C-70°C
Applicable door thickness	35-65mm



Fingerprint



Password



Card



Key



Temporary password



Ttlock App (Optional)



Tuya App (Optional)



USB

Black Silver

PRODUCT SIZE

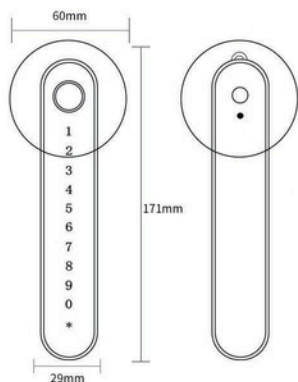

OPTIONAL LOCK BODY



Single Tongue Lock Body



50 series lock body

50 series side strips apply 125mm-200mm



72 series lock body



85 lock body



4558 lock body

Intelligent lock cylinder



Fingerprint head

TECHNICAL PARAMETERS/FUNCTIONS

Product model	0704
Main material	Aluminium alloy
Fingerprint/password capacity	300
Card capacity	1000
Product color	Black/Silver/Gold
Power supply mode	4*AAA
Packing specification	1ctn 12PCS
Whole package parameters	0.025m ³
Weight of the whole CTN	7.3kg
Applicable temperature	-20°C-55°C
Applicable door thickness	35-70mm



Password



Fingerprint



Card



Key



APP unlock



Ttlock App (Standard)



Tuya App (Standard)



USB

PRODUCT SIZE



Golden
 Black
 Silver



Intelligent lock cylinder



TECHNICAL PARAMETERS/FUNCTIONS

Product model	0705
Main material	Aluminium alloy
Password/card capacity	1250
Product color	Black/Silver/Gold
Power supply mode	4*AAA
Packing specification	1ctn 12PCS
Whole package parameters	0.025m ³
Weight of the whole CTN	7.3kg
Applicable temperature	-20°C-55°C
Applicable door thickness	35-70mm



Password



Key



APP unlock



Card



Ttlock App
(Standard)



Tuya App
(Standard)



USB

PRODUCT SIZE



Golden

Black

Silver



Wire-free fingerprint swipe card lock



Stainless Steel
 Black

TECHNICAL PARAMETERS/FUNCTIONS

Product model	0801
Main material	Aluminium alloy
Fingerprint/password/credit card capacity	Total 200
Product color	Black/Stainless Steel
Power supply mode	4*AA
Packing specification	1ctn 12PCS
Whole package parameters	0.065m ³
Weight of the whole CTN	18.5kg
Applicable temperature	-20°C-70°C
Applicable door thickness	40-120mm



Fingerprint



Password



Card



Key



Temporary password



Ttlock App (Optional)



Tuya App (Optional)



USB

PRODUCT SIZE

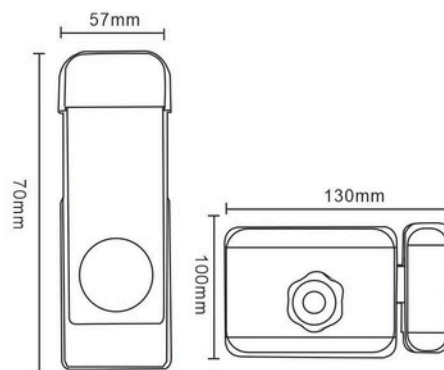

Wire-free fingerprint swipe card lock



Stainless Steel
 Black

TECHNICAL PARAMETERS/FUNCTIONS

Product model	0802
Main material	Aluminium alloy
Fingerprint/password/credit card capacity	Total 300
Product color	Black/Stainless Steel
Power supply mode	4*AA
Packing specification	1ctn 12PCS
Whole package parameters	0.065m ³
Weight of the whole CTN	17.5kg
Applicable temperature	-20°C-70°C
Applicable door thickness	40-120mm



Fingerprint



Password



Card



Key



Temporary
password



Ttlock App
(Optional)



Tuya App
(Optional)



USB

PRODUCT SIZE

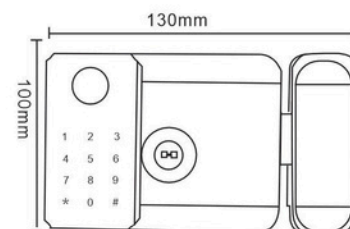
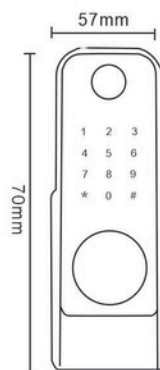

Wire-free fingerprint swipe card lock

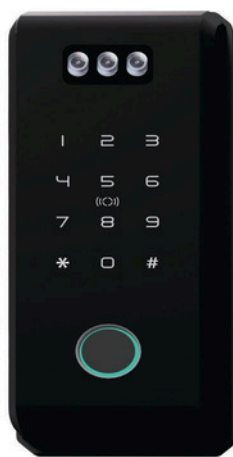

Facial style



Basics



 Black

TECHNICAL PARAMETERS/FUNCTIONS

Product model	0803
Main material	Aluminium alloy
Fingerprint/password/credit card capacity	Total 100
Product color	Black
Power supply mode	4*AA
Packing specification	1ctn 20PCS
Whole package parameters	0.059m ³
Weight of the whole CTN	16.2kg
Applicable temperature	-20°C~70°C
Applicable door thickness	35-55mm



Fingerprint



Password



Card



Key



Temporary password



Tuya App



USB

PRODUCT SIZE

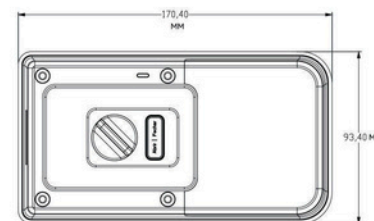

Semi-automatic bridge breaking aluminum smart lock



Long handle



Short handle

Black

TECHNICAL PARAMETERS/FUNCTIONS

Product model	0901
Main material	Aluminium alloy
Product color	Black
Power supply mode	4*AA
Packing specification	1ctn 10PCS
Whole package parameters	0.057m ³
Weight of the whole CTN	14.69kg
Applicable temperature	-10°C-60°C
Applicable door thickness	30-120mm



Fingerprint



Password



Card



Key



Temporary password



Tlock App (Optional)



Tuya App (Customized)



USB

PRODUCT SIZE

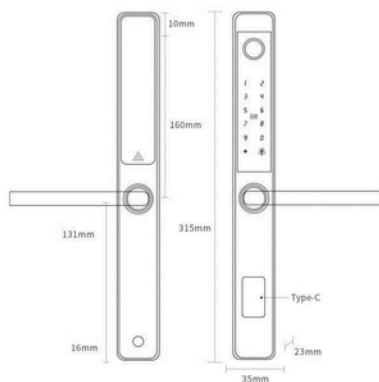

OPTIONAL LOCK BODY



85 series multi-point lock body



85 series single point lock body



85 double channel series single point lock body



85 double-channel series multi-point lock body

Semi-automatic bridge breaking aluminum smart lock



Black
 Silver

PRODUCT SIZE

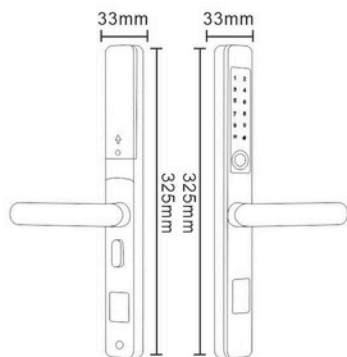

TECHNICAL PARAMETERS/FUNCTIONS

Product model	0902
Main material	Aluminium alloy
Fingerprint/password/credit card capacity	Total 200
Product color	Black/Silver
Power supply mode	4*AAA
Packing specification	1ctn 10PCS
Whole package parameters	0.13m ³
Weight of the whole CTN	21.2kg
Applicable temperature	-30°C-60°C
Applicable door thickness	30-120mm

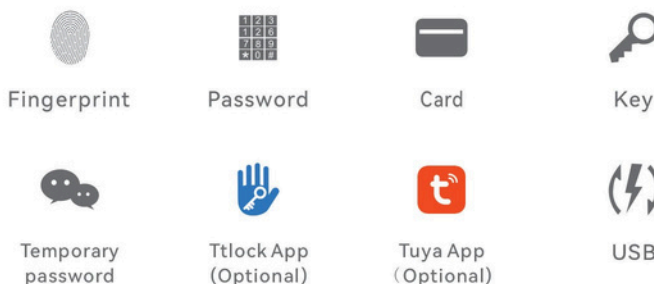

OPTIONAL LOCK BODY

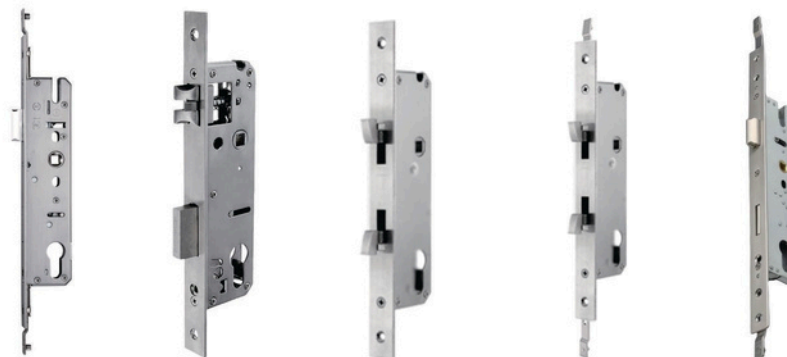

85 series multi-point lock body

85 series single point lock body

85 double channel series single point lock body

85 double-channel series multi-point lock body

92 series single point lock body

Semi-automatic bridge breaking aluminum smart lock



Short handle

Golden
 Black
 Silver

TECHNICAL PARAMETERS/FUNCTIONS

Product model	0905
Main material	Aluminium alloy
Fingerprint/password/credit card capacity	Total 200
Product color	Black/Golden/Silver
Power supply mode	4*AAA
Packing specification	1ctn 10PCS
Whole packageparameters	0.13m ³
Weight of the wholeCTN	20.7kg
Applicable temperature	-20°C-70°C
Applicable door thickness	30-120mm



Fingerprint



Password



Card



Key



Temporary password



Ttlock App (Optional)



Tuya App (Optional)



USB

PRODUCT SIZE

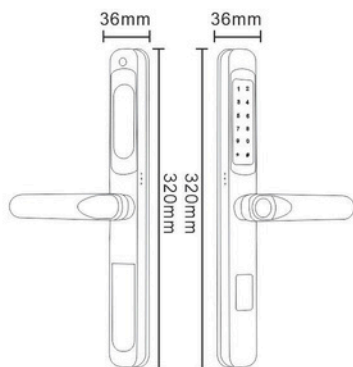

OPTIONAL LOCK BODY



85 series multi-point lock body



85 series single point lock body



85 double channel series single point lock body



85 double-channel series multi-point lock body



92 series single point lock body

Semi-automatic bridge breaking aluminum smart lock



Optional low handles for front and rear

 Black

PRODUCT SIZE

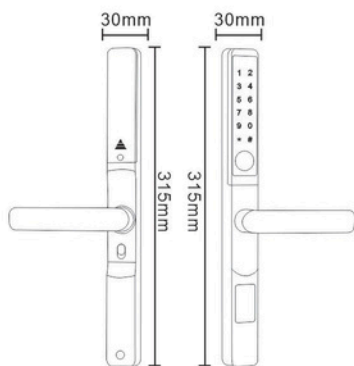

TECHNICAL PARAMETERS/FUNCTIONS

Product model	0907
Main material	Aluminium alloy
Fingerprint/password/credit card capacity	Total 300
Product color	Black
Power supply mode	4*AAA
Packing specification	1ctn 10PCS
Whole package parameters	0.13m ³
Weight of the whole CTN	19.4kg
Applicable temperature	-20°C-70°C
Applicable door thickness	30-120mm

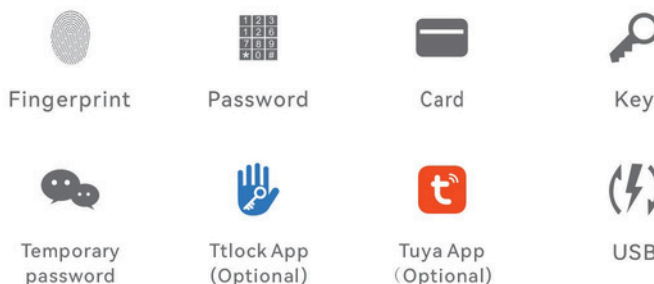

OPTIONAL LOCK BODY



85 series multi-point lock body

85 series single point lock body

85 double channel series single point lock body

85 double-channel series multi-point lock body

92 series single point lock body

Semi-automatic bridge breaking aluminum smart lock



Black
 Silver

TECHNICAL PARAMETERS/FUNCTIONS

Product model	0908
Main material	Aluminium alloy
Fingerprint/password/credit card capacity	Total200
Face capacity	50
Product color	Black/ Silver
Power supply mode	3000mAH
Packing specification	1ctn 10PCS
Whole packageparameters	0.13m ³
Weight of the wholeCTN	22.95kg
Applicable temperature	-25°C-70°C
Applicable door thickness	30-120mm

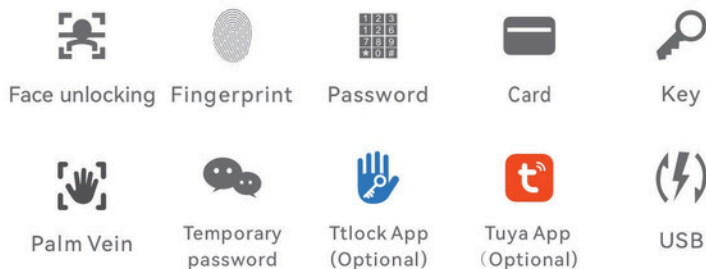

PRODUCT SIZE

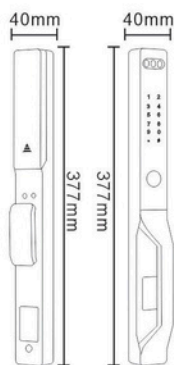

OPTIONAL LOCK BODY



85 series multi-point lock body

85 series single point lock body

85 double channel series single point lock body

85 double-channel series multi-point lock body

92 series single point lock bod

Glass door smart lock



Gray

TECHNICAL PARAMETERS/FUNCTIONS

Product model	1101
Main material	Aluminium alloy
Fingerprint/password/credit card capacity	Total 200
Product color	gray
Power supply mode	4*AA
Packing specification	1ctn 10PCS
Whole package parameters	0.057m ³
Weight of the whole CTN	14.58kg
Applicable temperature	-20°C-70°C
Applicable door thickness	8-12mm

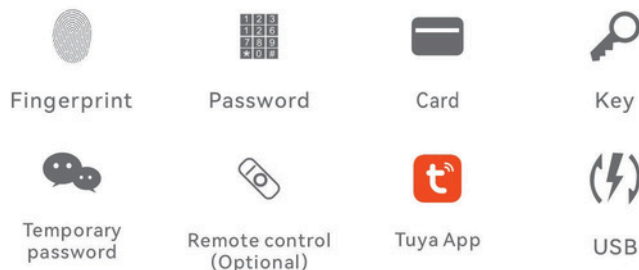

PRODUCT SIZE

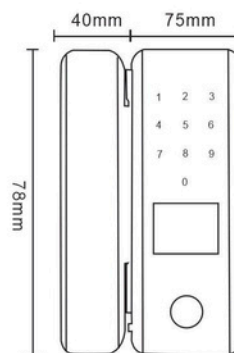



Glass door smart lock



 Black

TECHNICAL PARAMETERS/FUNCTIONS

Product model	1105
Main material	Aluminium alloy
Fingerprint/password/credit card capacity	Total 200
Product color	black
Power supply mode	4*AA
Packing specification	1ctn 10PCS
Whole package parameters	0.057m ³
Weight of the whole CTN	14.58kg
Applicable temperature	-20°C-70°C
Applicable door thickness	8-12mm



Fingerprint



Password



Card



Temporary password



Remote control (Optional)



Tuya App



USB

PRODUCT SIZE

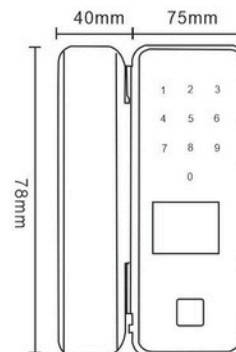

Padlock



 Black

TECHNICAL PARAMETERS/FUNCTIONS

Product model	1004
Main material	Aluminium alloy
Fingerprint capacity	50
Product color	Black
Power supply mode	500mAh lithium battery
Packing specification	1ctn 20PCS
Whole package parameters	0.015m ³
Weight of the whole CTN	12.5kg
Applicable temperature	-20°C-70°C



Fingerprint



Key



USB



Ttlock App
(Optional)



Tuya App
(Optional)

PRODUCT SIZE

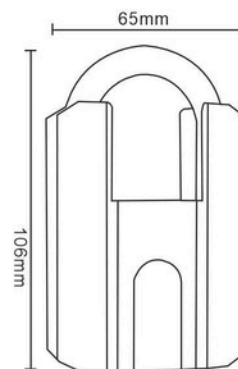

Hotel swipe card lock



 Sandy gold

 Steel color

 Black

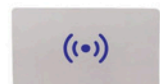

White card

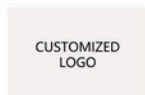

Color card



Card sender

TECHNICAL PARAMETERS/FUNCTIONS

Product model	1203
Main material	Stainless steel
Credit card capacity	unlimited
Product color	Placer gold/Alight/Black
Power supply mode	4*AA
Packing specification	1ctn 6PCS
Whole package parameters	0.083m ³
Weight of the whole CTN	16.8kg
Applicable temperature	-20°C-70°C
Applicable door thickness	38-50mm



Card



Key

PRODUCT SIZE

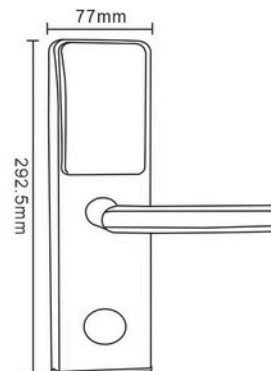

Hotel swipe card lock



TECHNICAL PARAMETERS/FUNCTIONS

Product model	1205
Main material	Aluminum alloy steel
Credit card capacity	unlimited
Product color	Black/Coffee copper
Power supply mode	4*AA
Packing specification	1ctn 6PCS
Whole package parameters	0.083m ³
Weight of the whole CTN	16kg
Applicable temperature	-20°C-70°C
Applicable door thickness	38-50mm



Card



Key

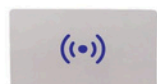

White card



Color card



Card sender

PRODUCT SIZE



Black

Coffee copper

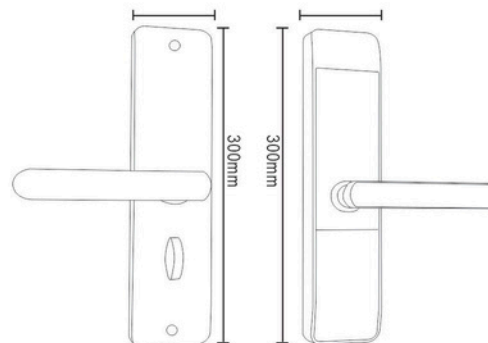



CARD HERE

EMERGENCY UNLOCK

Hotel swipe card lock



Coffee brown
 Black

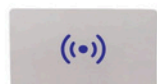

White card

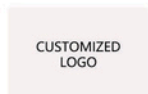

Color card



Card sender

TECHNICAL PARAMETERS/FUNCTIONS

Product model	1206
Main material	Aluminum alloy steel
Credit card capacity	unlimited
Product color	Black/Coffee brown
Power supply mode	4*AA
Packing specification	1ctn 6PCS
Whole package parameters	0.083m ³
Weight of the whole CTN	16.8kg
Applicable temperature	-20°C-70°C
Applicable door thickness	38-50mm



Card



Key

PRODUCT SIZE

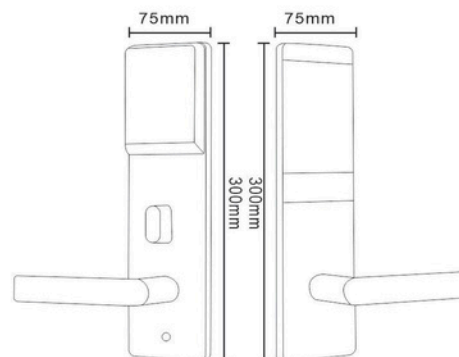

Hotel swipe card lock

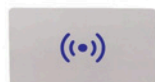
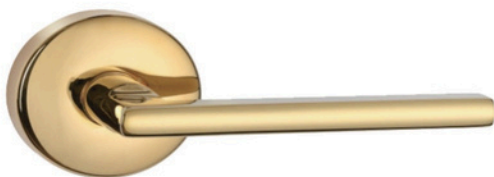

White card

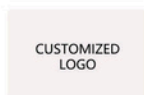

Color card



Card sender



Sandy gold

Alight

Black

TECHNICAL PARAMETERS/FUNCTIONS

Product model	1207
Main material	zinc alloy
Credit card capacity	unlimited
Product color	Placer gold/Alight/Black
Power supply mode	4*AA
Packing specification	1ctn 6PCS
Whole package parameters	0.083m ³
Weight of the whole CTN	22.9kg
Applicable temperature	-20°C-70°C
Applicable door thickness	38-50mm



Card



Key

PRODUCT SIZE

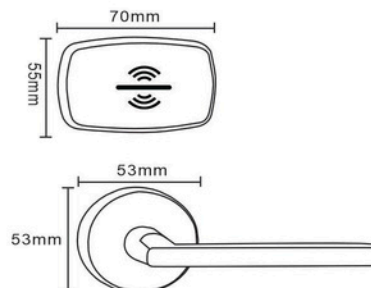

68 SERIES



1401 【388*30mm】
60/70/75/80/8568

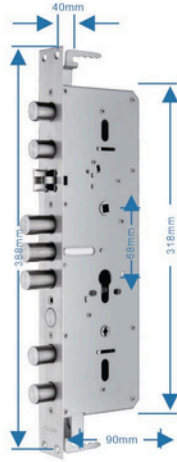

1402 【388*40mm】
60/70/75/80/8568

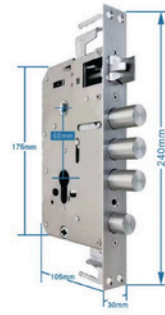

1403 【240*30mm】
60/70/75/80/8568



1404 【240*24mm】
60/70/75/80/8568

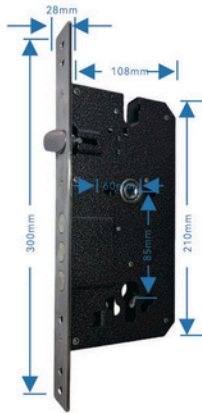

6085

RUSSIA SERIES 60×85MM

TURKISH SPECIAL LOCK BODY

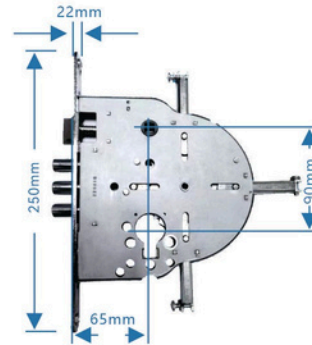

6590

65×90MM

ISRAEL SPECIAL LOCK BODY

85 SERIES



1405 [240*22mm]



1406 [240*22mm]



1407 [240*22mm]



1408 [240*22mm]

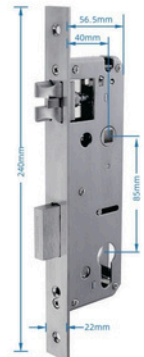

1409 [240*22mm]

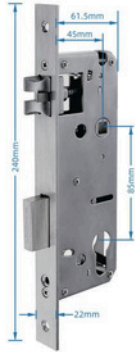

1410 [240*22mm]



1411 [240*22mm]



1412 [240*22mm]



1413 [240*22mm]



1414 [240*22mm]



1415 [240*22mm]



1416 [240*22mm]



1417 [240*22mm]

92 SERIES



1424 【30*92mm】

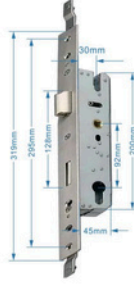

1425 【30*92mm】



1426 【34*92mm】



1427 【34*92mm】

72 SERIES



1437 【235*22mm】



1438 【235*20mm】



1439 【235*22mm】



1440 【235*22mm】

OTHER LOCK BODY SERIES

Single Tongue Lock Body



1441 【60-70mm】

Dead Bolt Lock Body



1442 【60mm】



1444

4558 lock body

50 SERIES

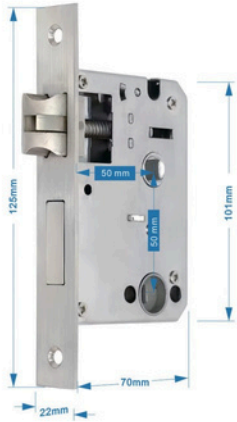

1428 [125*22mm]

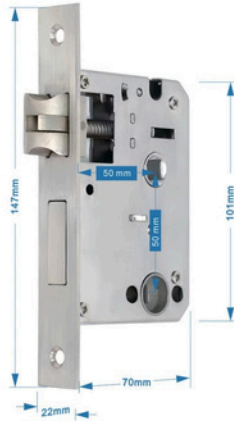

1429 [147*22mm]



1430 [160*22mm]



1431 [165*22mm]

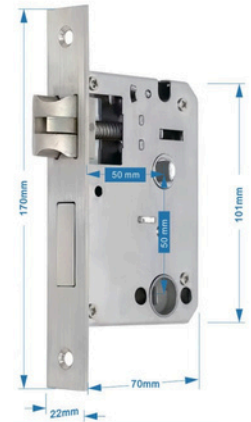

1432 [170*22mm]

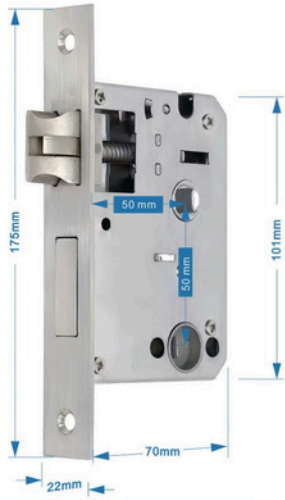

1433 [175*22mm]



1434 [180*22mm]



1435 [190*22mm]

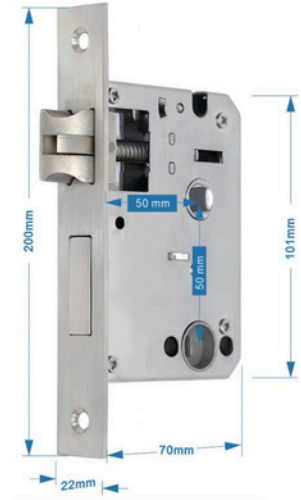

1436 [200*22mm]

Lock Frame



1601

Dimensions high 440
chassis wide 240

Suitable for single tongue
lock body/single lock



1623

Dimensions high 400
chassis wide 250

Suitable for Bull Head Lock



1624

Dimensions high 360
chassis wide 225

Suitable for Glass Lock



1603

Dimensions high 440
chassis wide 240

Suitable for 50 lock body
single lock



1610

Size height 600
chassis width 240

Applicable 6068 lock body
24*240/ single lock



1606

Size height 600
chassis width 240

Applicable 3585 lock
body/single lock

Accessories



Special anti-collision stickers



Special lithium battery
(3500/4200/5000mAh)



Small lithium battery
(2500mAh)



Special data cable



Certificate of Conformity



Back Screen