

www.lumilife.ae

ALWAYS
CHOOSE SMART

LED LIGHTING
QUICK CATALOG



INTRODUCTION

ABOUT COMPANY

At **Lumilife**, we illuminate your world with innovation, elegance, and sustainability. Based in the United Arab Emirates, our mission is to provide high-quality, energy-efficient lighting solutions tailored to meet the diverse needs of modern homes, businesses, and outdoor spaces. With a deep commitment to excellence, **Lumilife** offers a wide range of cutting-edge lighting products designed to enhance both functionality and aesthetics. Whether you're creating a cozy ambiance for your home, designing a vibrant workspace, or lighting up expansive outdoor areas, our products are crafted to deliver brilliance and reliability.

Our focus on sustainability drives us to embrace eco-friendly technologies that reduce energy consumption while maintaining exceptional performance. At **Lumilife** we believe in lighting up lives responsibly and stylishly.

Explore our catalog to discover lighting solutions that blend technology, design, and innovation – because with **LUMILIFE- ALWAYS CHOOSE SMART**

ALORA SERIES

GAMBLING ART

MODERN LIGHT MODERN LIFE



Lighting Effect

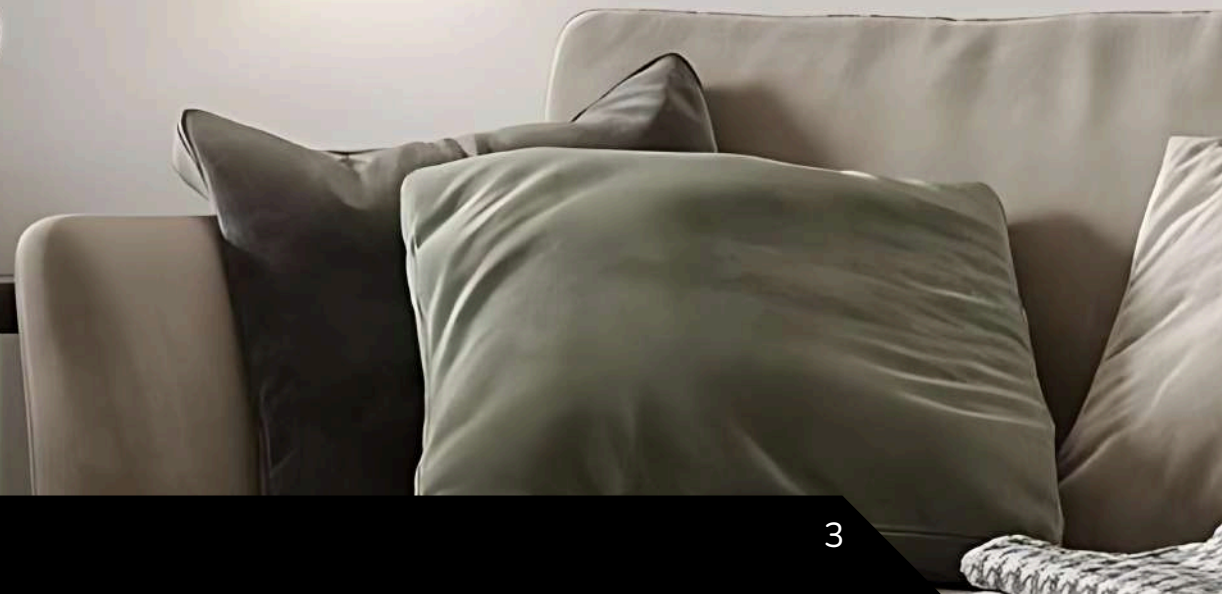

SIDE LIGHTING EFFECT



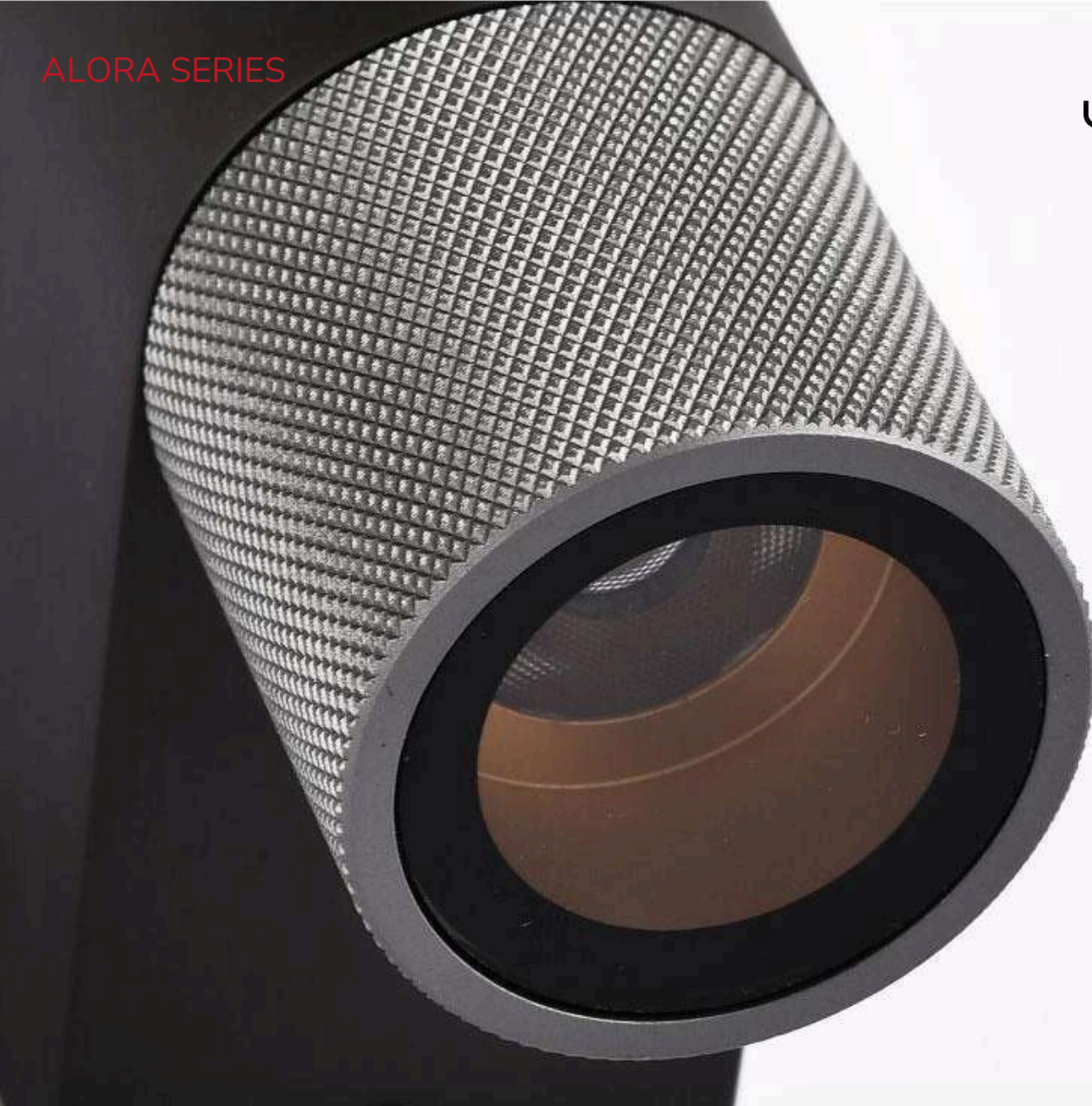

Quality Assurance

Real Material, all aluminum die casting, and the button is also aluminum
waterproof Anti-rust and Anti-corrosion

ALORA SERIES

HIGHLIGHT LED CHIP

High light **Transmission**, **energy** saving, **bright** highlight, high color rendering index

BLAZE SERIES



Ceiling Recessed

This series luminaire dresses the light with 45degree convex lens and builds the space with a circular, classic and light silhouette. Its language between the technical and the decorative, nature and modern, redefines this archetype with a walnut wood cover in a pure geometry of circular shape, and a placid and homogeneous projected light that invites to enjoy. Available in recessed installation, with 15W, 24W, 30W different dimensions, This series spotlight meets different requirements in applications. You can use it to easily create a spectacular lighting for your restaurant, bar, hotel and home.

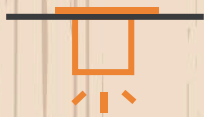

Mounting

2700K,3000K
4000K,500K,6000K

Color Temperature





A walnut wood cover

Nature and modern, This Series redefines this archetype with a walnut wood cover in a pure geometry of circular shape.

45degree convex lens

With 45degree convex lens, light is perfectly distributed to illuminate each material on display. SALIENT recessed This a soft, intimate and accent light on every applications.



BLAZE SERIES

A variety dimensions

Available in different diameters: 150mm, 200mm, 270mm, This series offers 15W, 24W,30W to meets different requirements in applications.

CRYSTAL SERIES

Ceiling Recessed

These luminaires have a compact design and are suitable for use in environments where space is limited or where discreet installation is required, such as confined spaces, recessed lighting, interior lighting of furniture, etc.



Mounting

2700K,3000K
4000K,500K,6000K

Color Temperature





CRYSTAL SERIES

Using advanced heat dissipation technology and materials, through the special fin design, it can quickly and effectively dissipate heat in a short time and improve heat dissipation efficiency.

Using advanced heat dissipation technology and materials, through the special fin design, it can quickly and effectively dissipate heat in a short time and improve heat dissipation efficiency.



Sturdy snap fastening

Using advanced heat dissipation technology and materials, through the special fin design, it can quickly and effectively dissipate heat in a short time and improve heat dissipation efficiency.

LUMINE SERIES

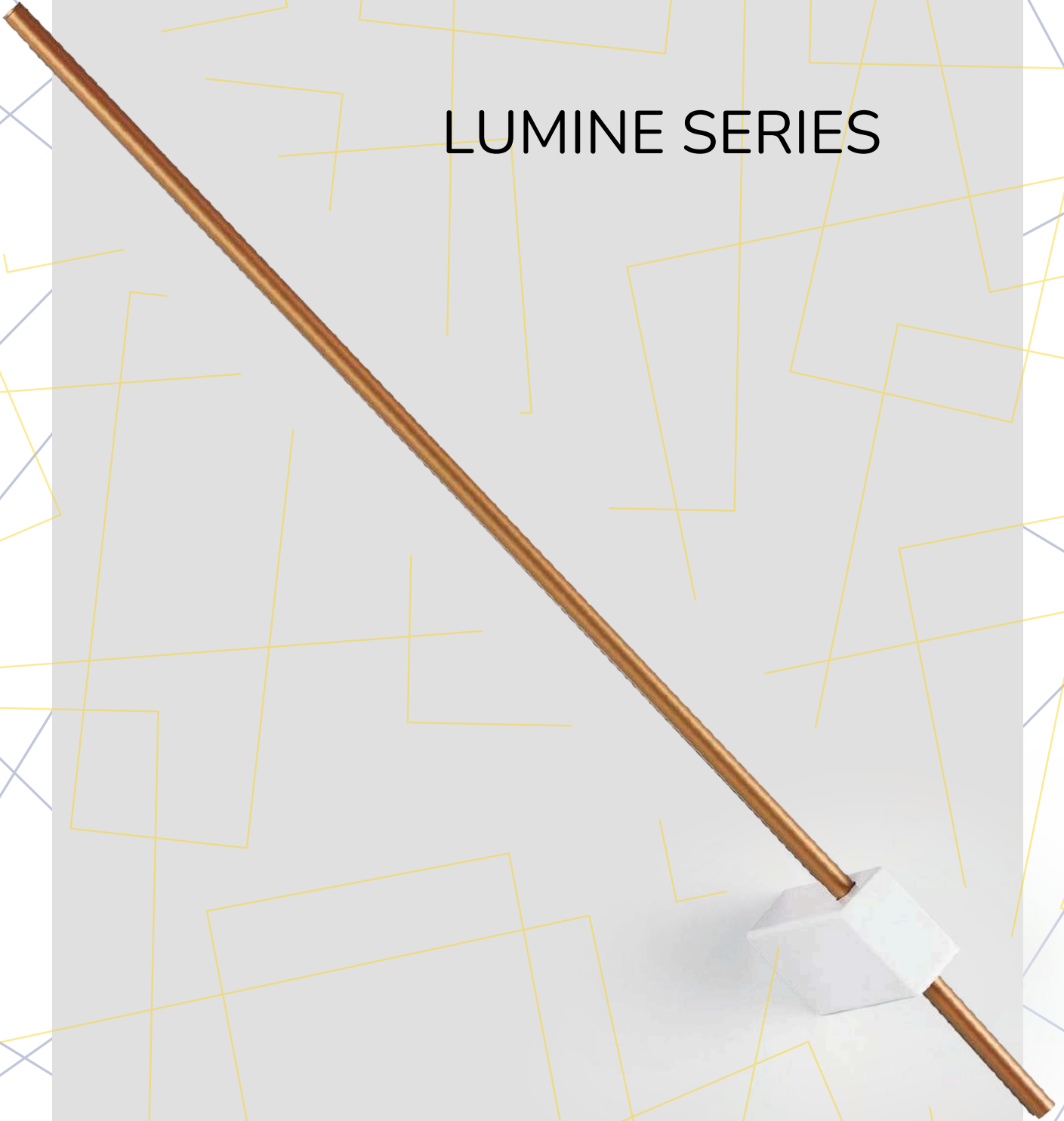

LUMINE SERIES

"Wall lights could be regarded as modern sculptures in personal space." Lumine series is a family of 5 sizes wafer-thin linear wall lights. The delicate designs are made of D10mm thin aluminum tubes, high light transmission PC cover, which creates very fine and reduced look that makes more imagination of design minimalists. This family displays the lights in the style of cozy atmosphere, which brings better life experience.

Less wall occupation

The mounted base design is compact drivers in seamlessly, which not only takes up relatively less wall space but also stands out overall aesthetics of the wall.

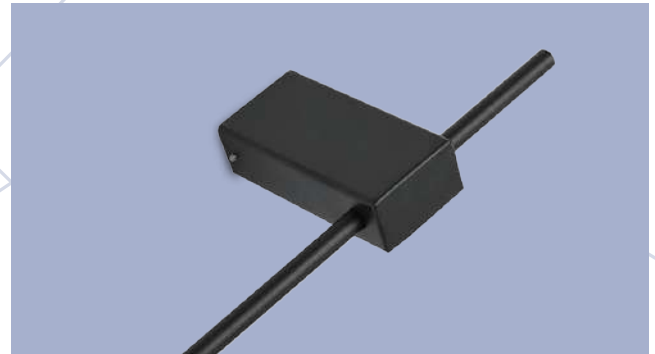

Aluminum lamp base

This is made of light Aluminum alloy material with corrosion resistance and delicate appearance.



Four housing colors available

- Sand white
- Sand black
- rose gold
- Sand white

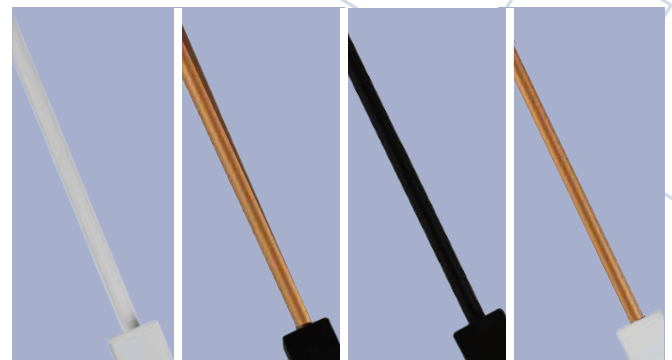

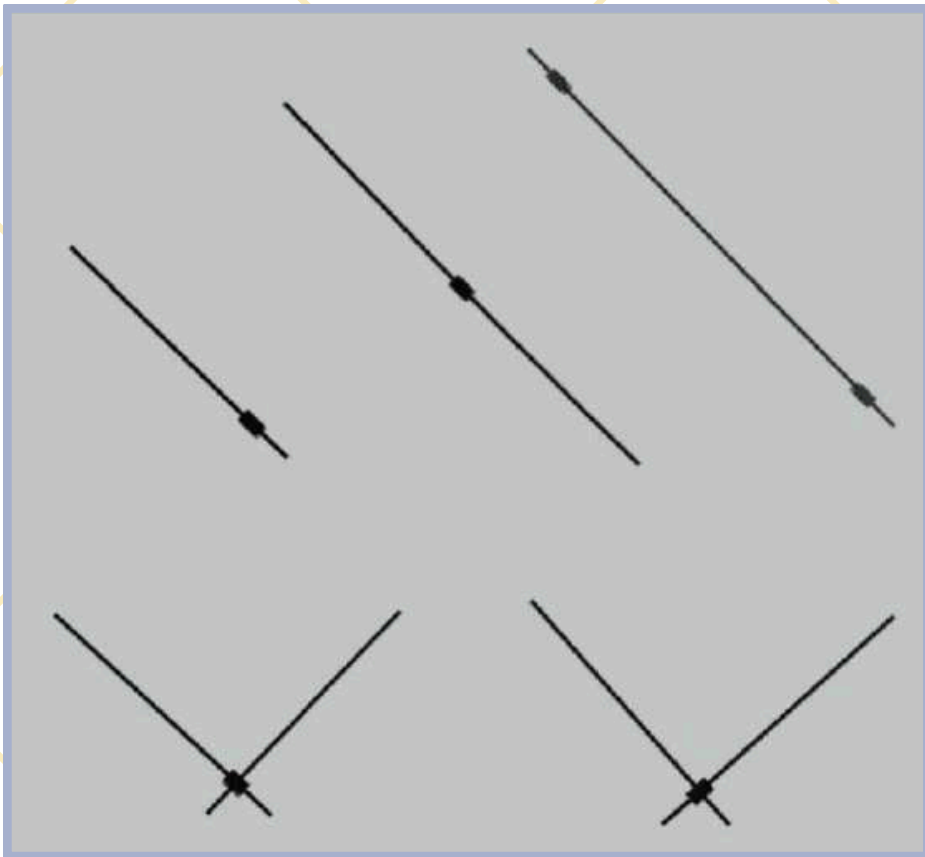

GOOD LIGHTING
DISPLAY
TURN OFF LIGHTS

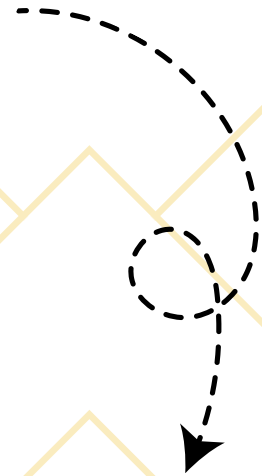

LUMINE SERIES

GOOD LIGHTING
DISPLAY
TURN ON LIGHTS

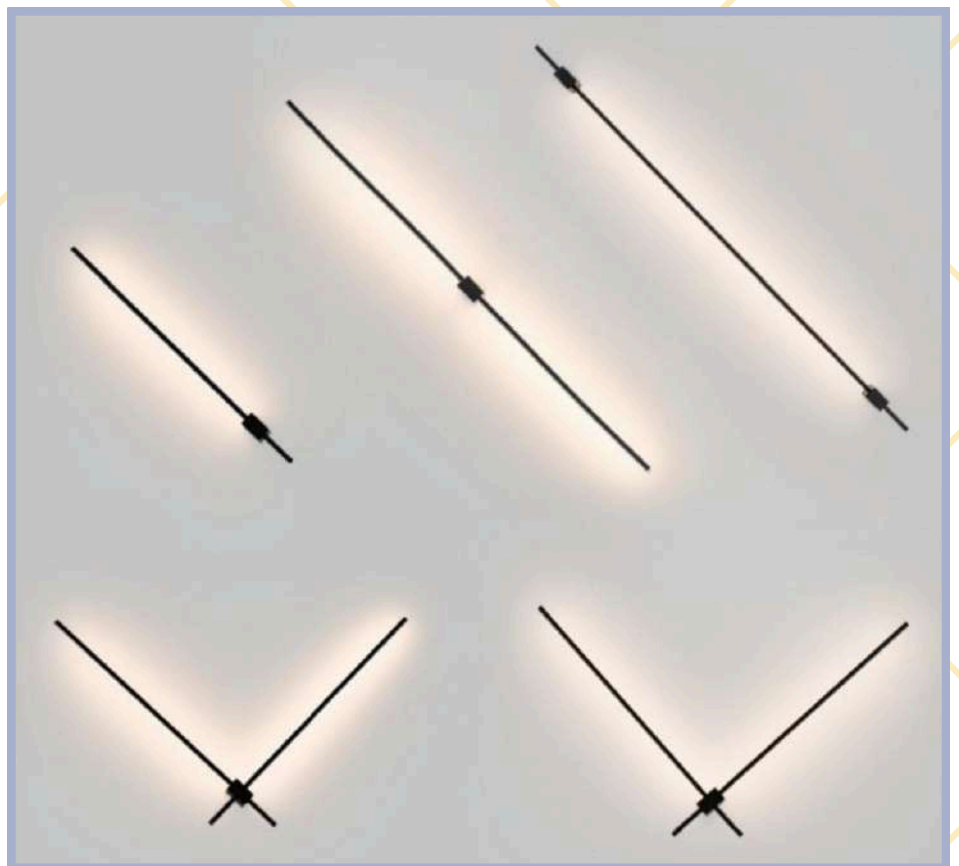

FOTIS SERIES

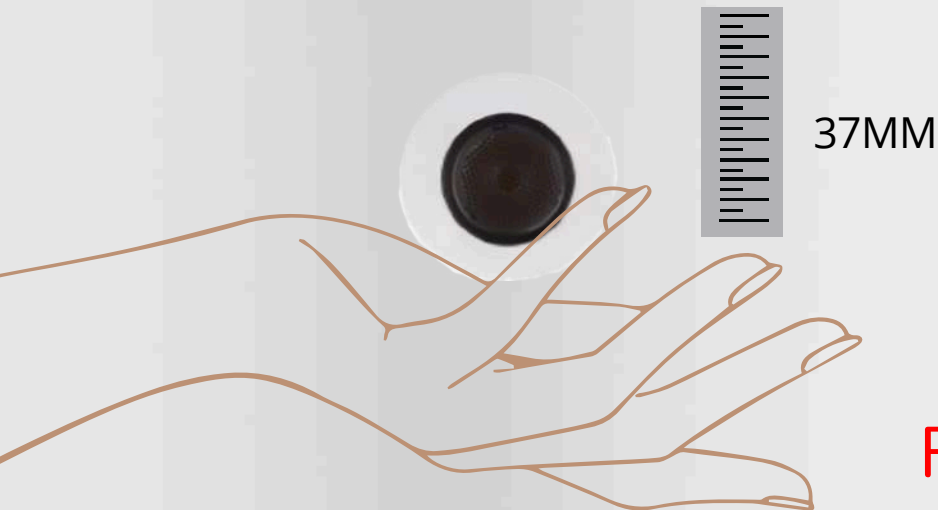

FOTIS SERIES

Small size of 37mm

The compact size of the lamp body makes it versatile and adaptable for a wide range of complex and creative lighting applications, including curved contours and uniquely shaped architectural surface lighting projects.



30mm Cut-out

The compact size of the lamp body makes it versatile and adaptable for a wide range of complex and creative lighting applications, including curved contours and uniquely shaped architectural surface lighting projects.



DAG SERIES

Sturdy snap fastening

Made of corrosion-resistant, wear-resistant, and high-temperature resistant materials, it can withstand the pressure and wear of long-term use, and prolong the service life of the lamp.



ELENA SERIES



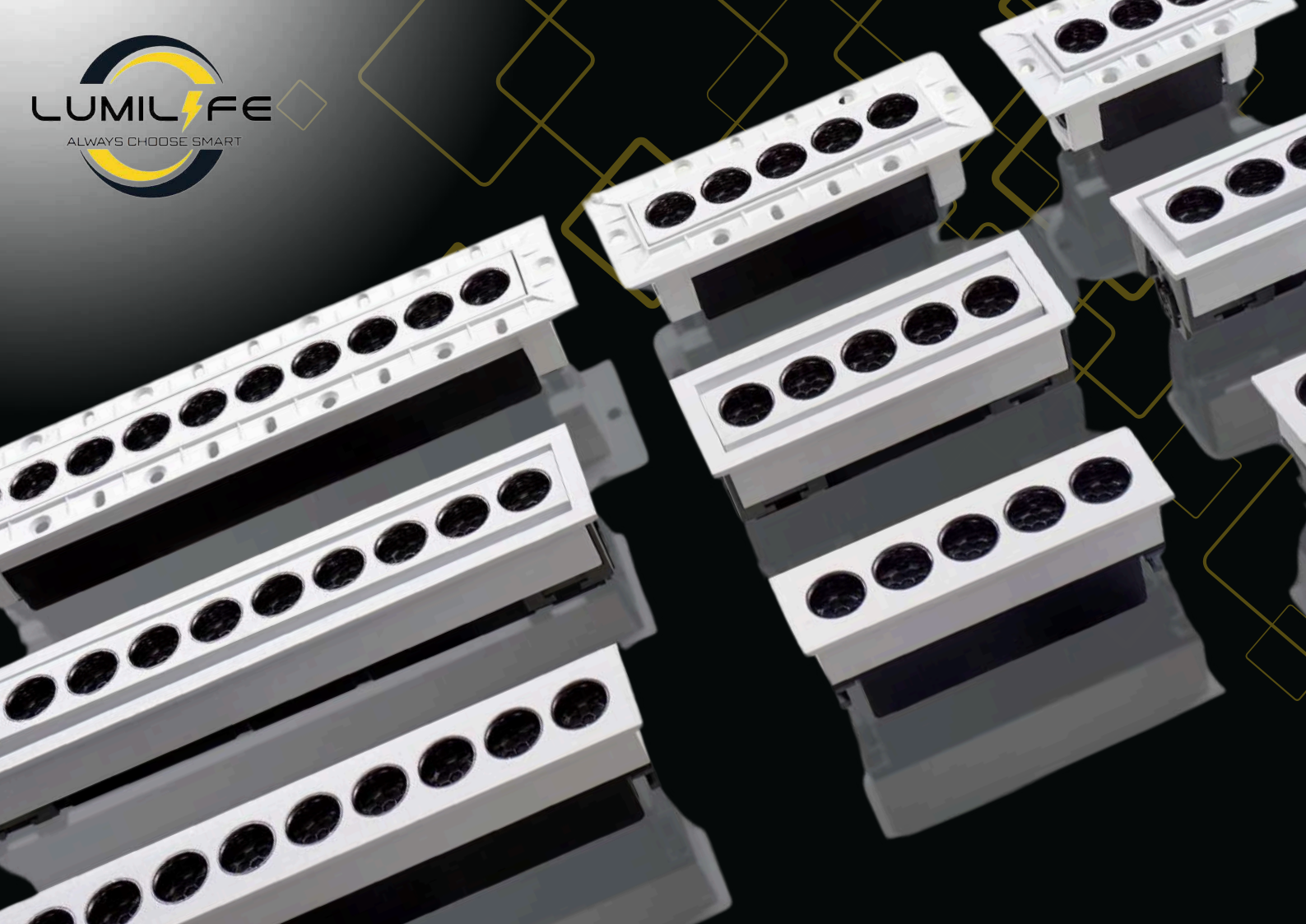

KIARA-SERIES

GRILL SERIES



KIARA-SERIES



KIARA-SERIES

Our goal is to provide you with luminaires that maintain their warm, welcoming glow for years to come. How do we achieve this? By upholding the highest product quality standards in line with the Ecodesign Directive and ensuring the availability of spare parts for an exceptionally long lifespan. If you ever need to replace your LED engine, rest assured that you can do so hassle-free for up to 20 years. And to make things even better, we back every product with a 5-year guarantee. It's our commitment to quality and reliability—lighting you can trust



LUX-SERIES

LUX-SERIES

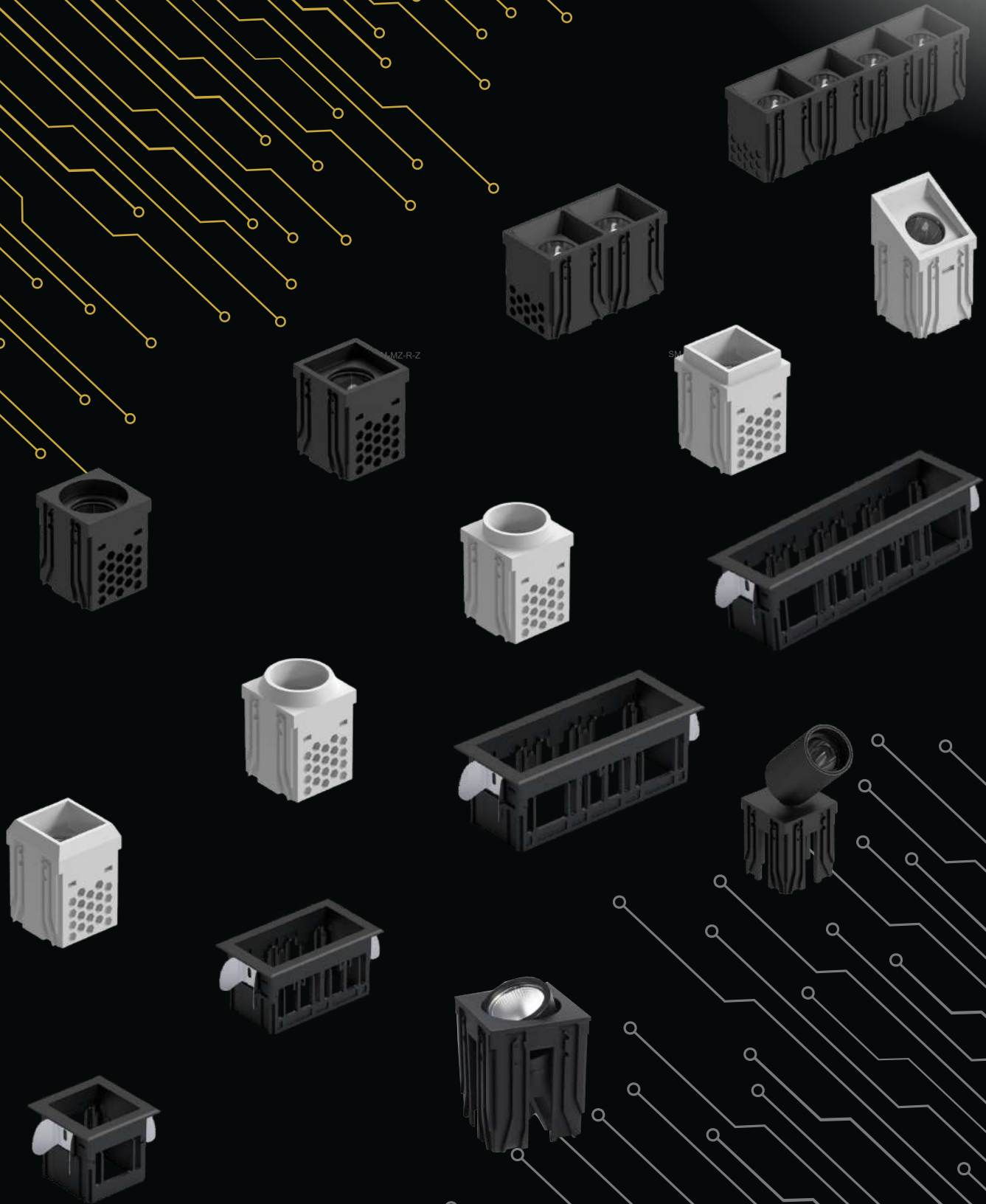



TYSON-SERIES

Family Design

A comprehensive range of spotlights offers diverse options to meet various needs, with outer rings which is available in multiple stylish designs to suit your preferences.

TYSON-SERIES

Iconic elements,
continue the classic



TYSON-SERIES

SHAPES



Everything Circular / Square / brimless

A variety of styles and lighting effects can be selected according to the lighting effect and surface ring. Each face ring has its own unique light effect.

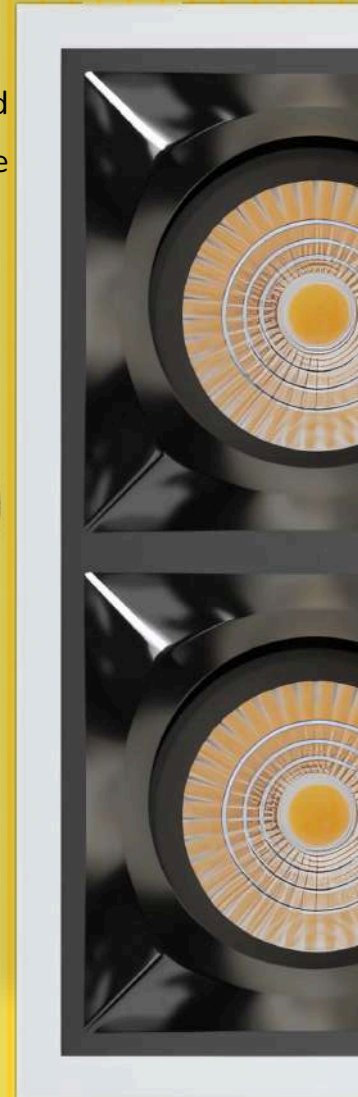

TYSON-SERIES COLOUR /FINISH

Available in 6 colors
Suitable for different
decoration
environments



The reflector showcases a unique blend of UV-resistant electroplating and advanced nano-paint technology, seamlessly adapting to diverse soft decoration environments with exceptional style and functionality.

TYSON-SERIES

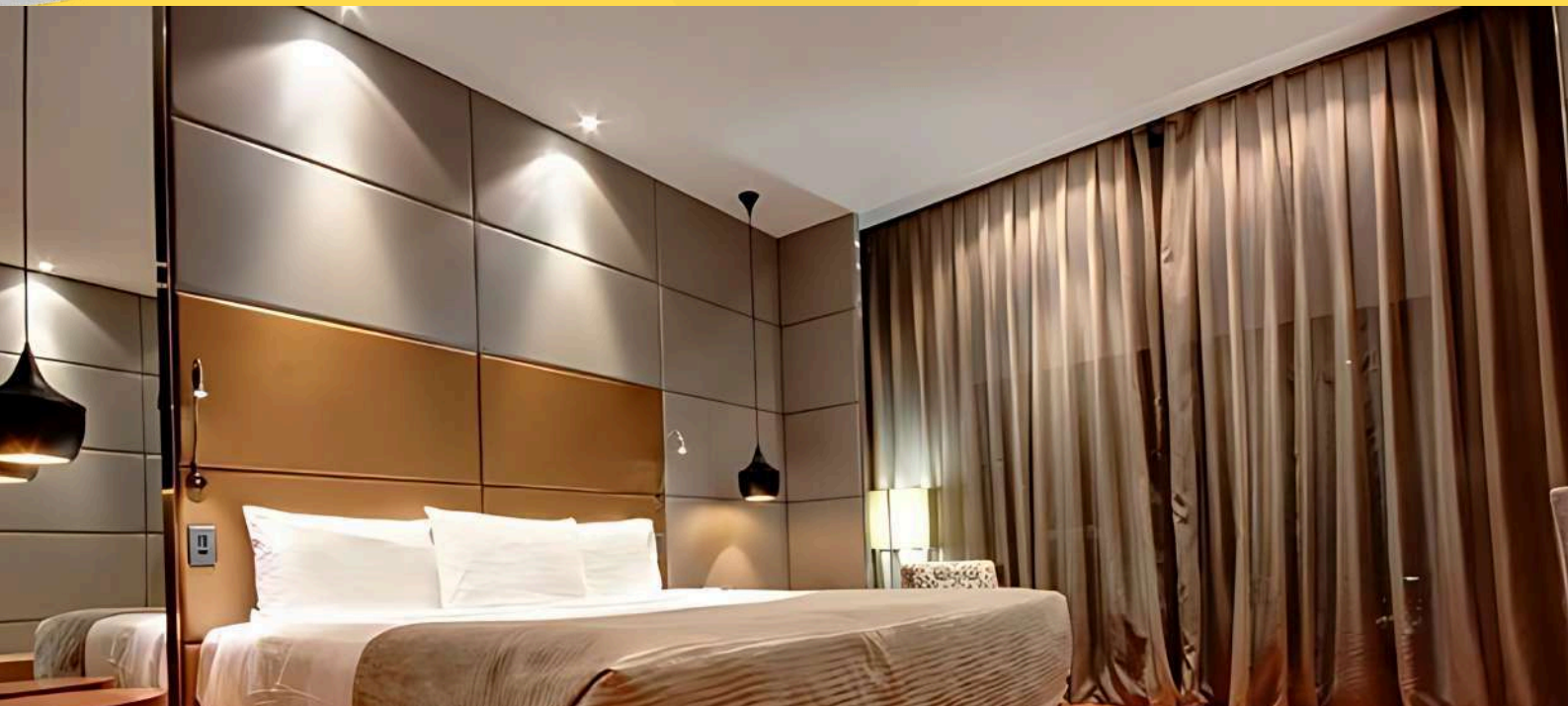
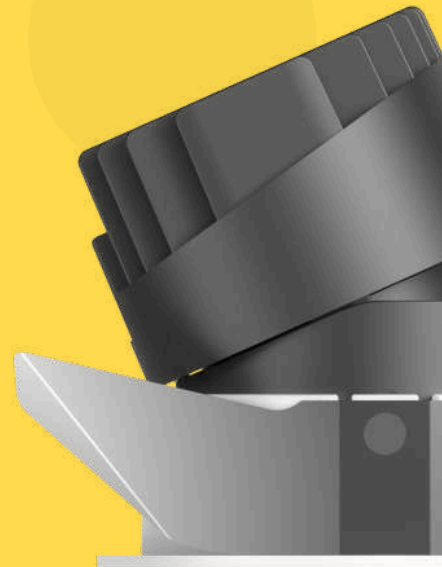
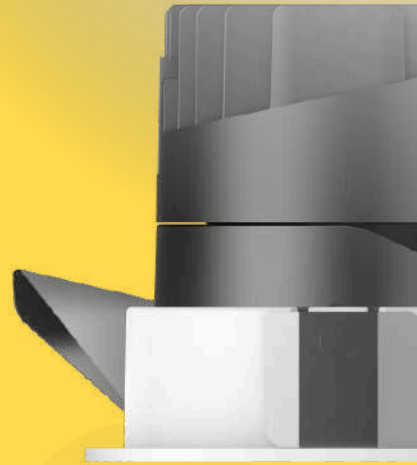
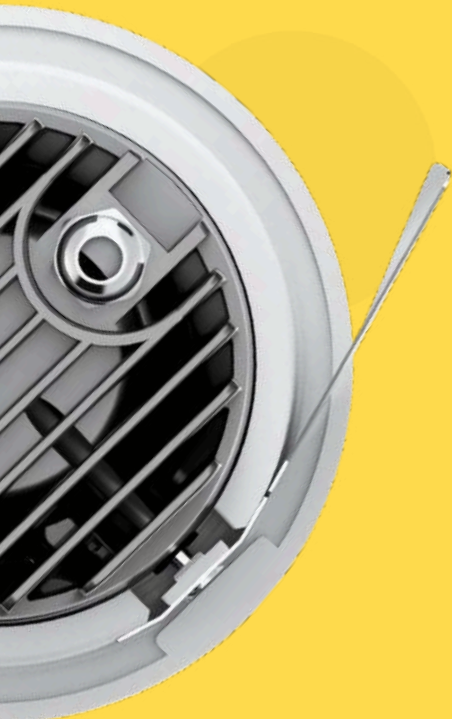

TYSON-SERIES STRUCTURE

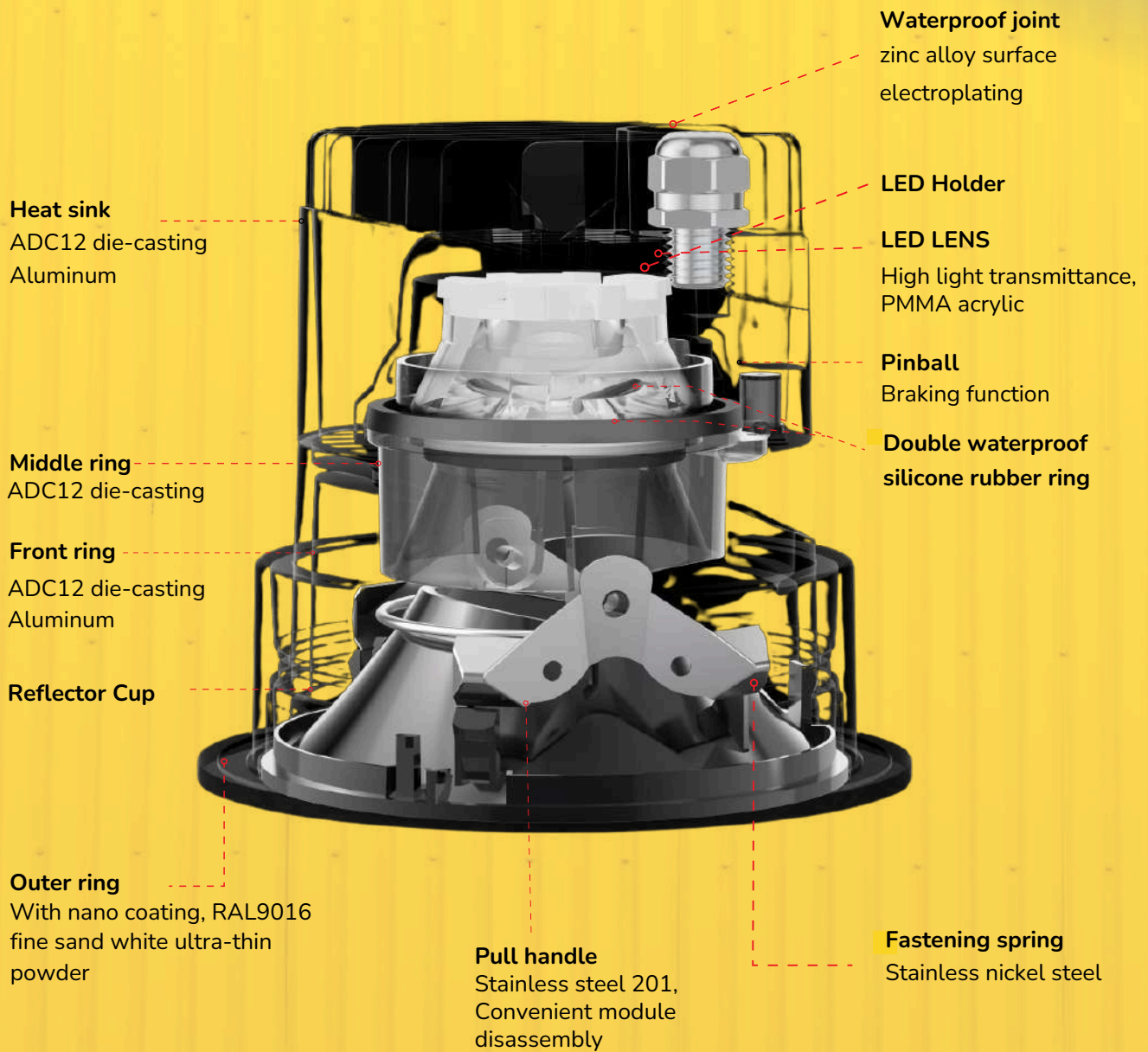

TYSON-SERIES ANTI GLARE FITTINGS

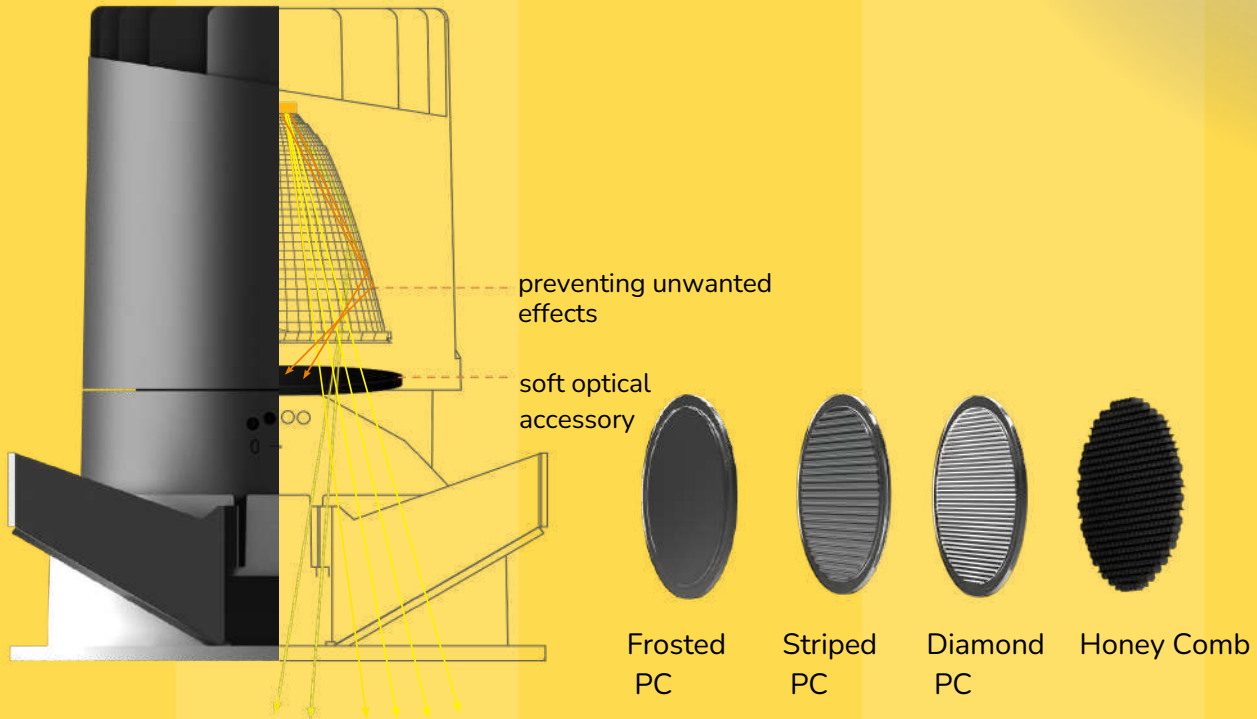

Creates a soft atmosphere by dividing the light source into small beams using soft optical accessories. This reduces glare and provides a balanced, gentle lighting environment. Different optical accessories produce varying luminous effects.

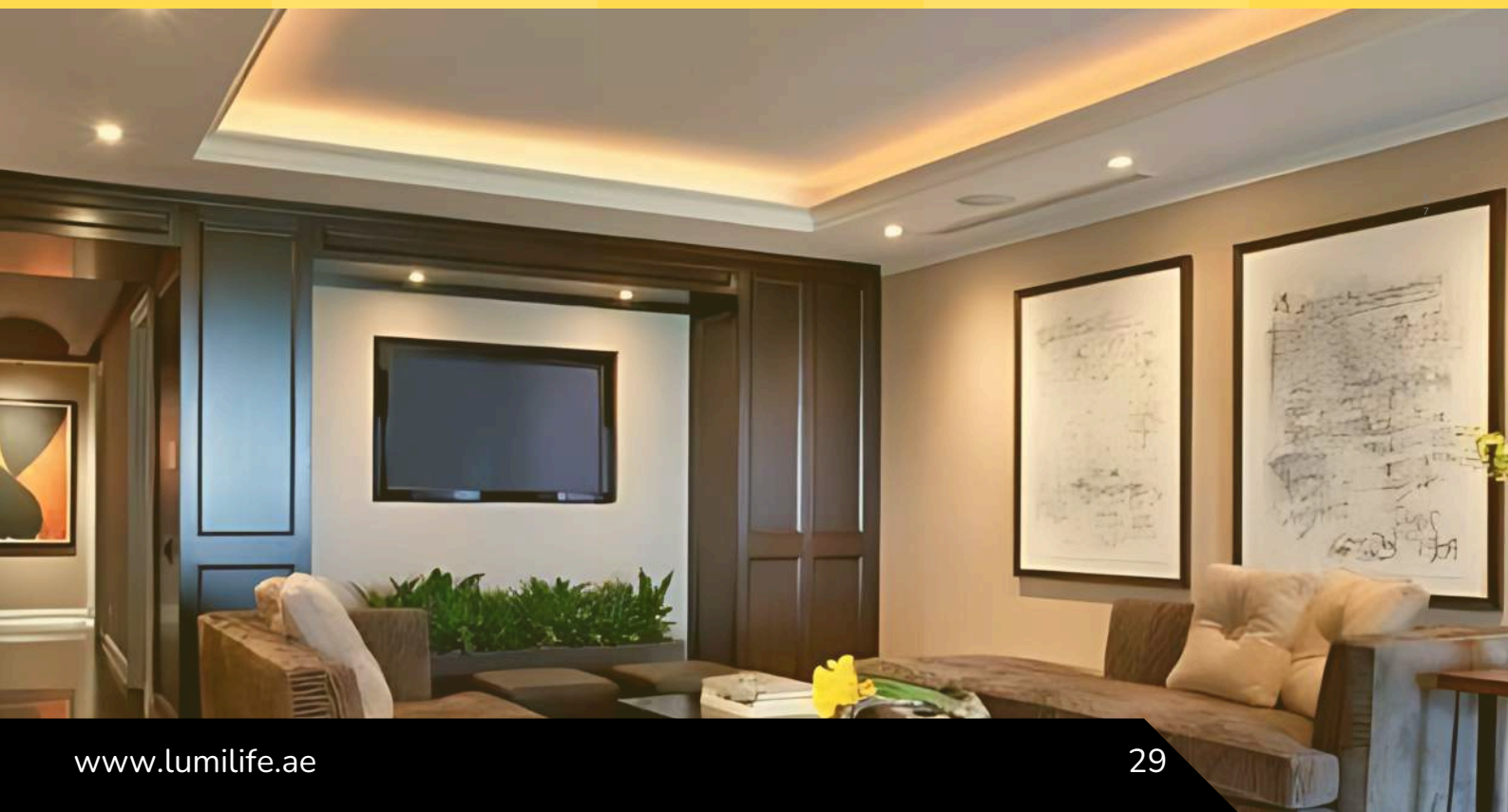

ROXANA-SERIES

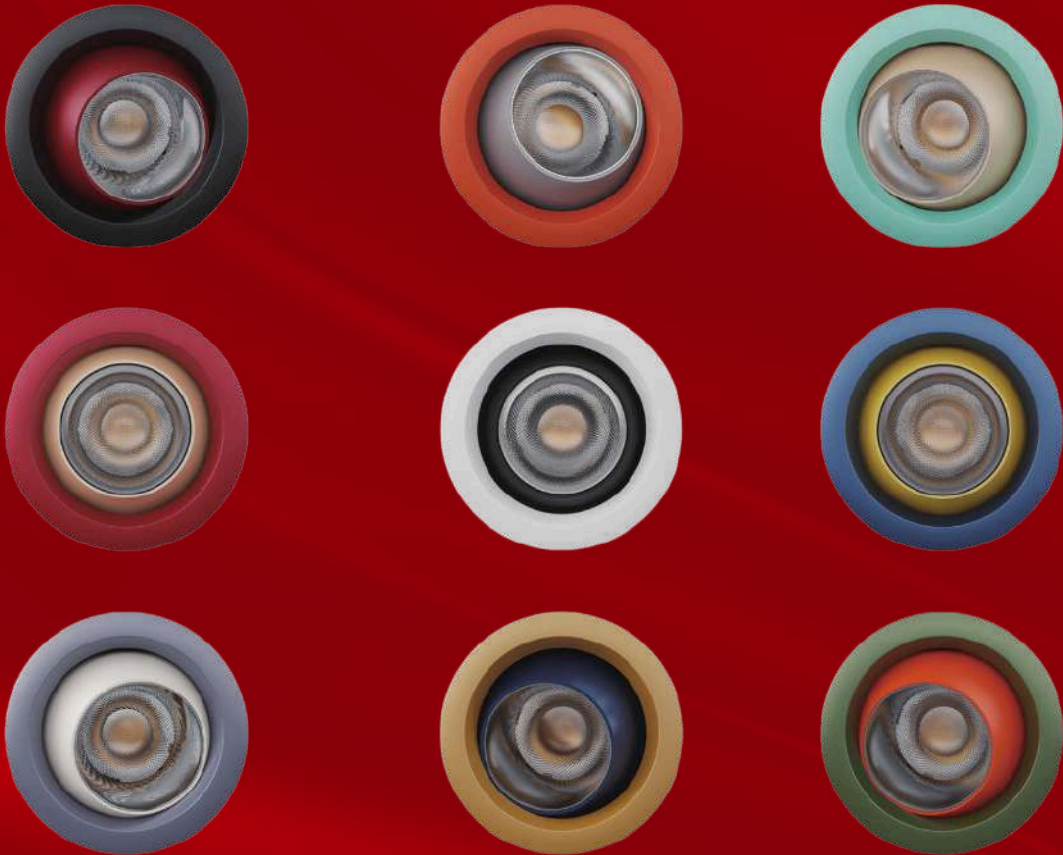

Bold. Vibrant. Urban flair.

These striking colors don't just match the city—they redefine it. Where mix-and-match meets the cutting edge, fashion takes the lead.

Through daring clashes and harmonious collisions, these colors speak a language that words simply cannot.



ROXANA SERIES FAMILY

Continuously improve the integrated product system, provide more comprehensive scene lighting applications, create multiple expressions of light, and inject new possibilities into your dream area.

ROXANA-SERIES



Misty silver



Matt white



Mirror light color



Champagne gold



Electroplated chrome black



Matt Black

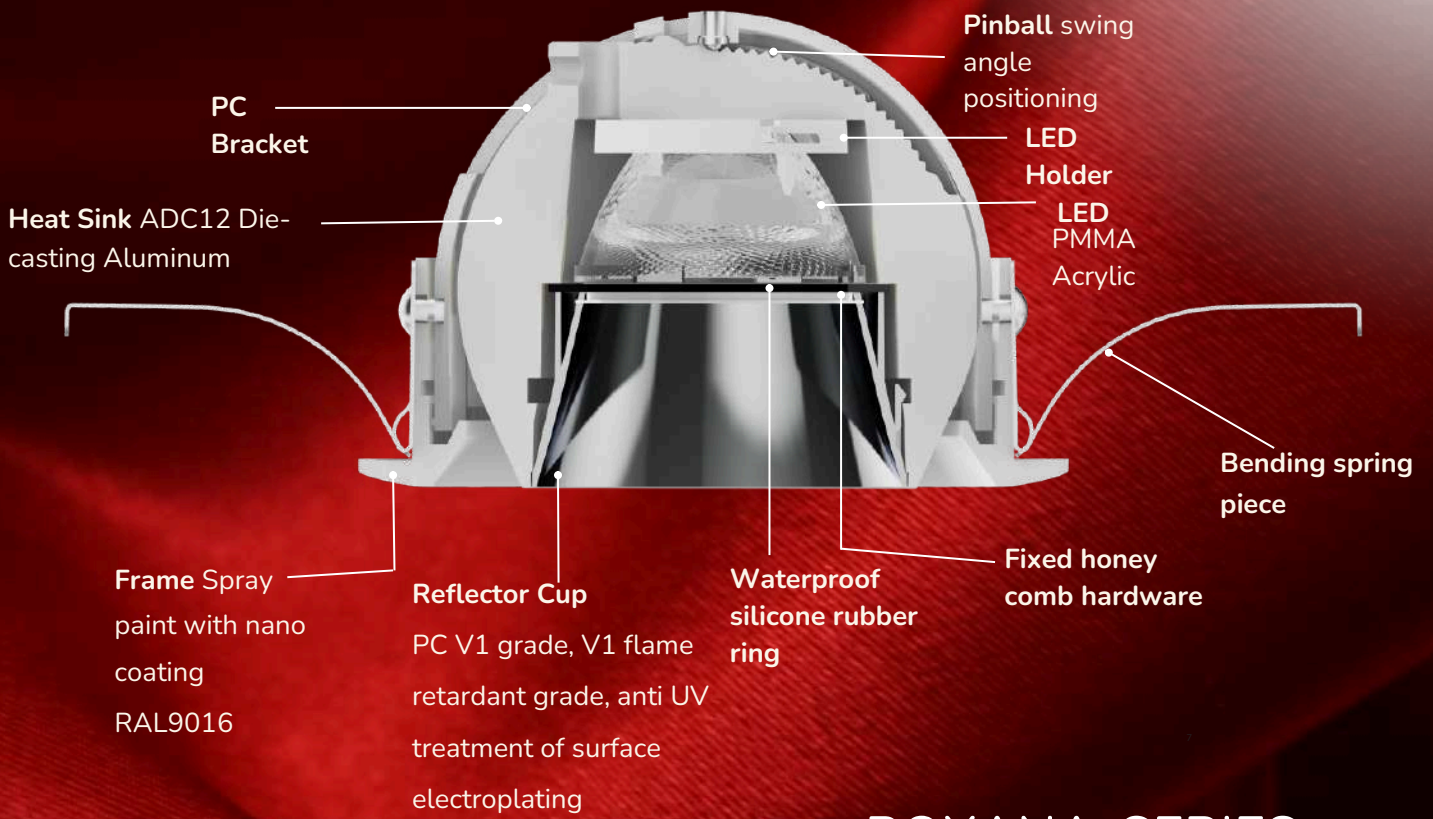

ROXANA-SERIES





- ✓ Anti -Glare
- ✓ Multi-colors available
- ✓ Color Customization supported

NORA-SERIES

IP65



IP65 WaterProof

NORA-SERIES



Water

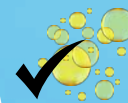

Oil



Smoke/fog

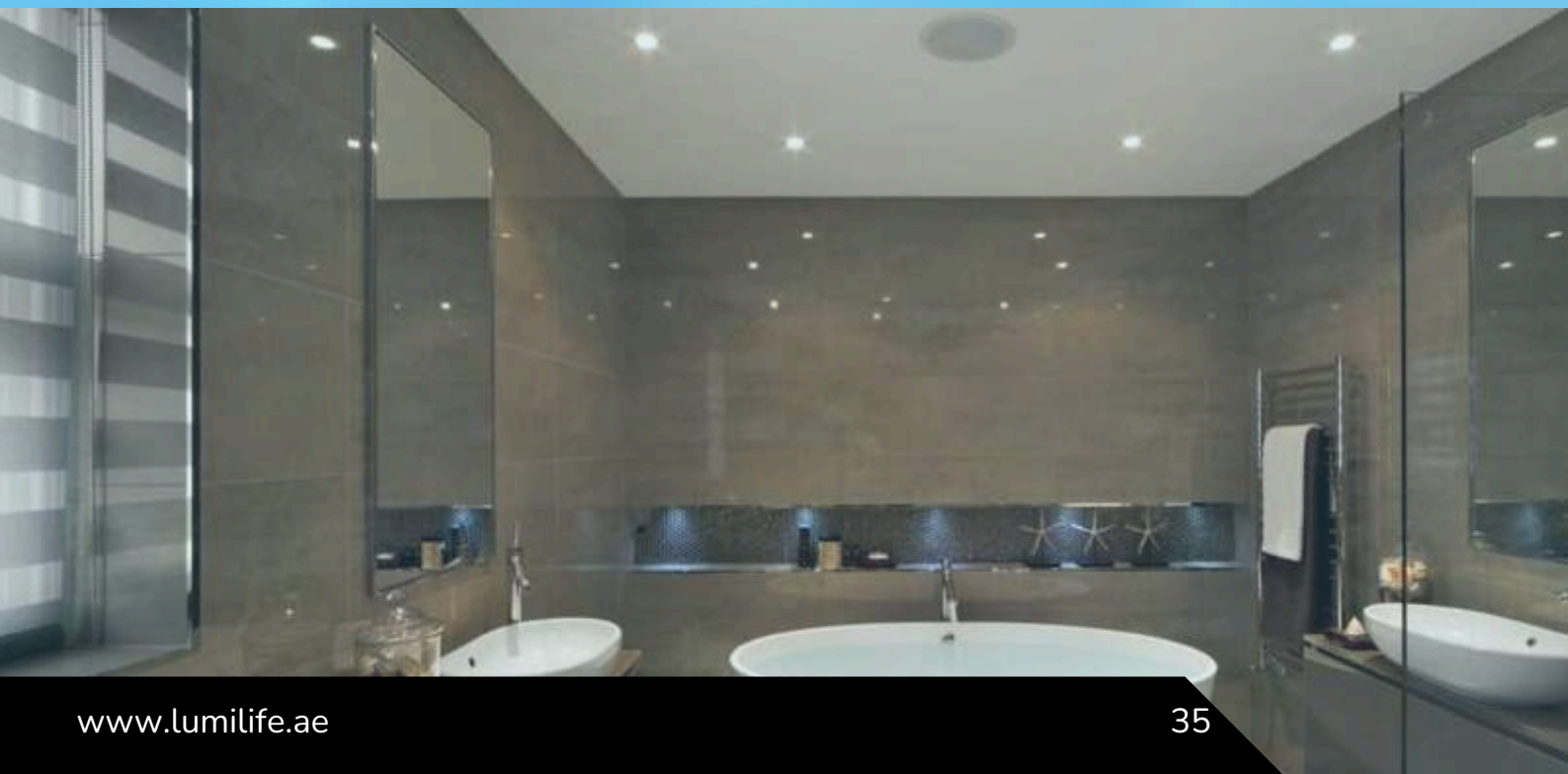



NORA-SERIES SPLIT STRUCTURE

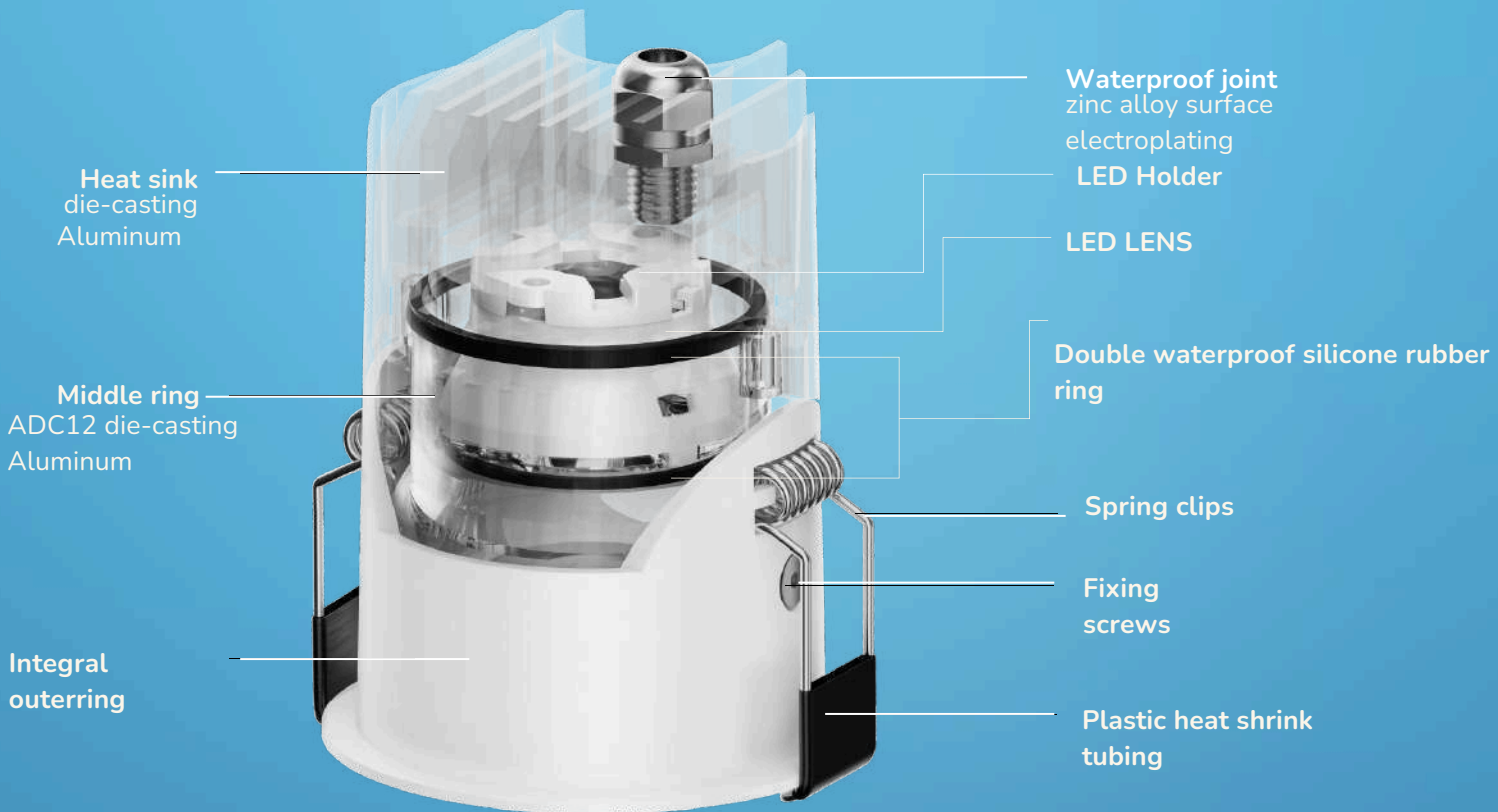

NORA-SERIES

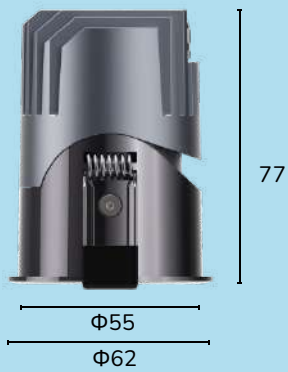
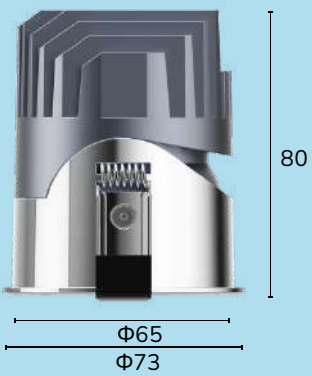

NORA-SERIES

Beauty in , more than one

Multi-coloured face rings ,The reflector is multi-color and can meet the needs of different occasions The reflector is precisely designed,plated and nano spray painted Comfortable light type with high reflection efficiency and high efficiency

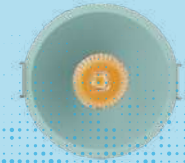
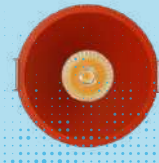
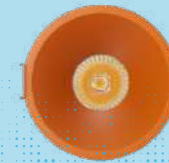
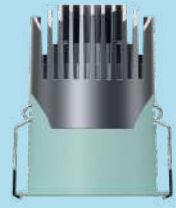
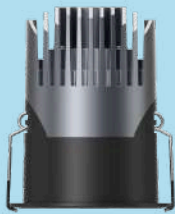



ORAN SERIES

Family

Full range of spotlights, different choices for different needs The face ring can be selected in a variety of styles

ORAN SERIES

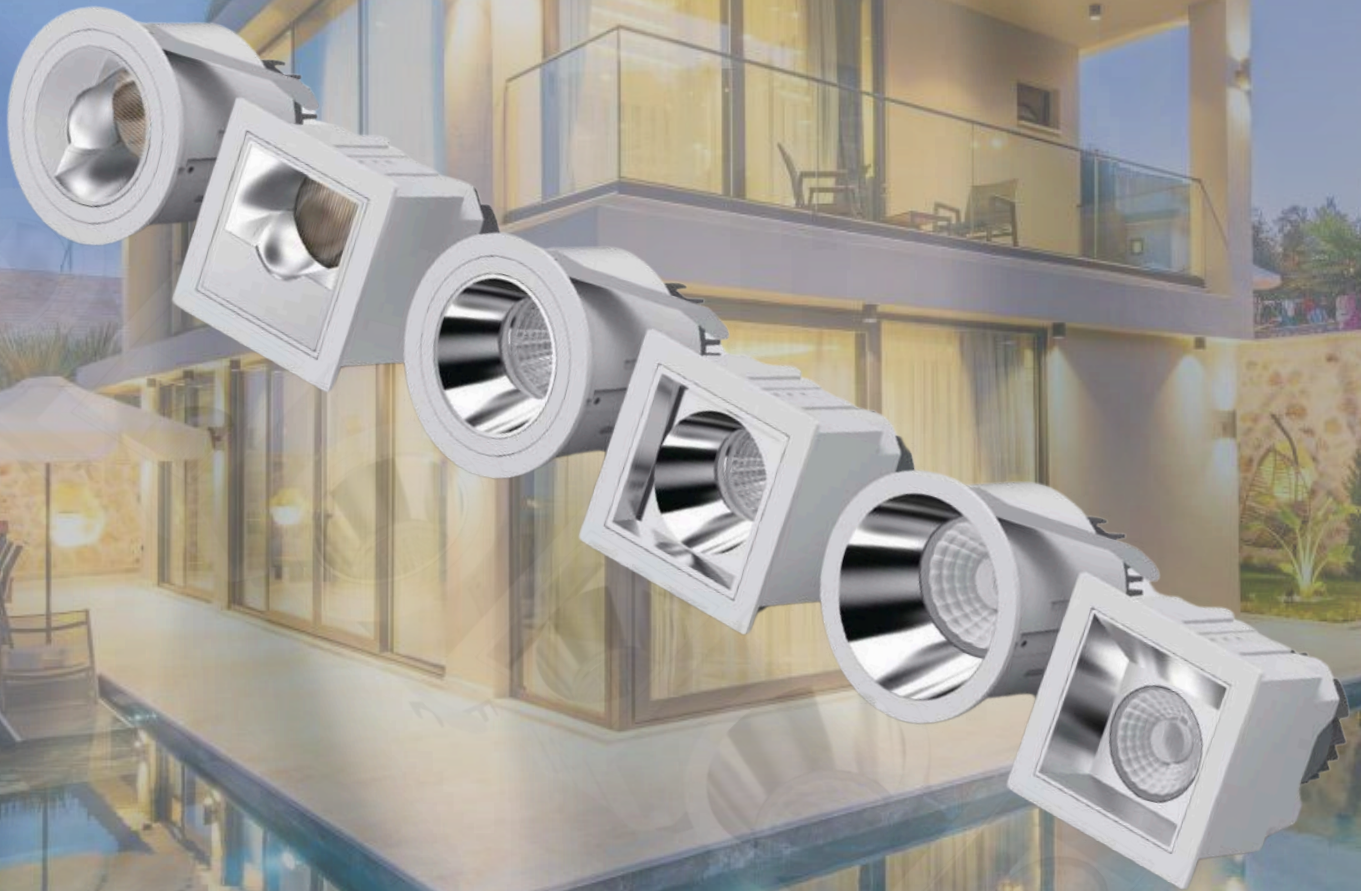

Excellent Design

From its innovative design concept to its advanced optical structure, efficient heat dissipation, and refined surface treatment, every detail reflects its exceptional uniqueness

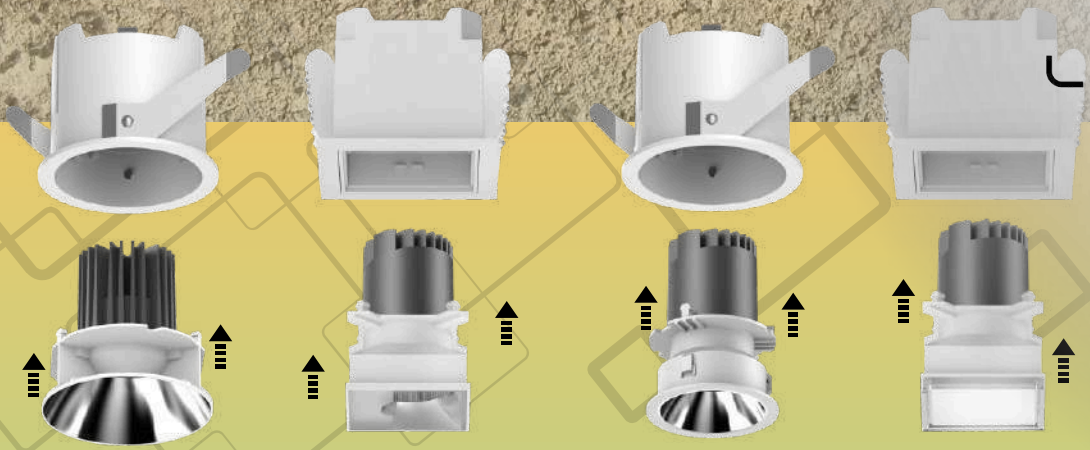

ORAN SERIES QUICK REPLACEMENT

To accommodate diverse lighting needs and simplify maintenance, a quick-replacement module has been designed. Simply press to remove the existing module and easily swap it with a new one

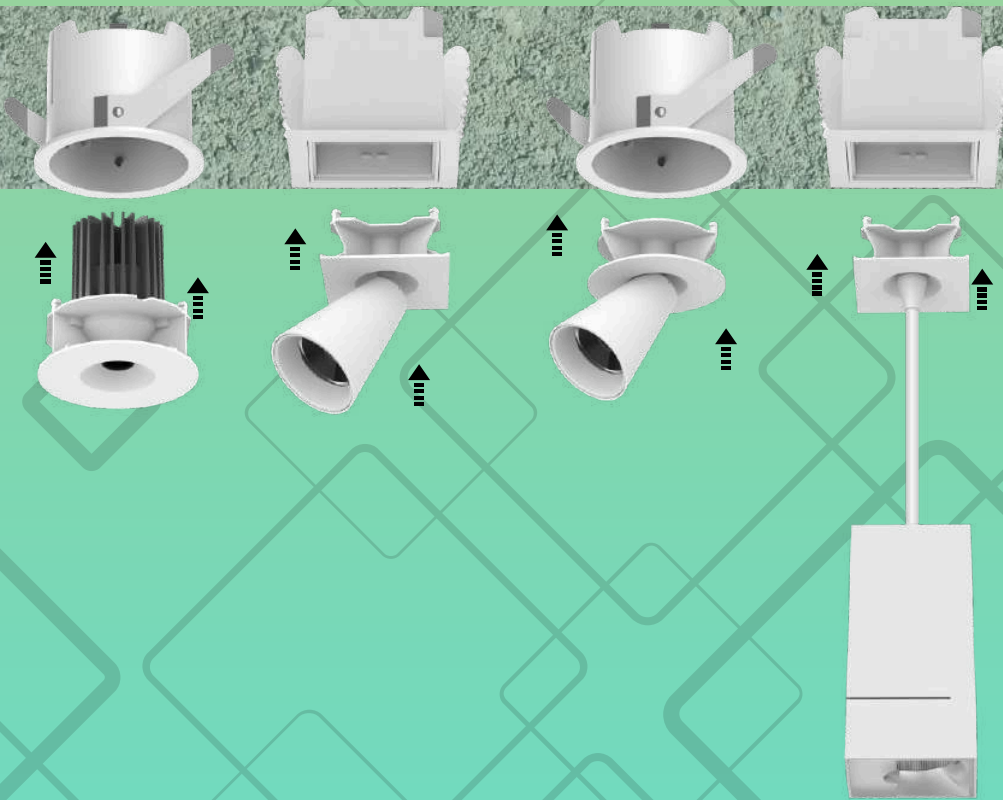

ADJUSTABLE SHAFT DESIGN

Tilttable 30° adjustable shaft offers unique light, direct illuminate mode and wash wall mode easily switch

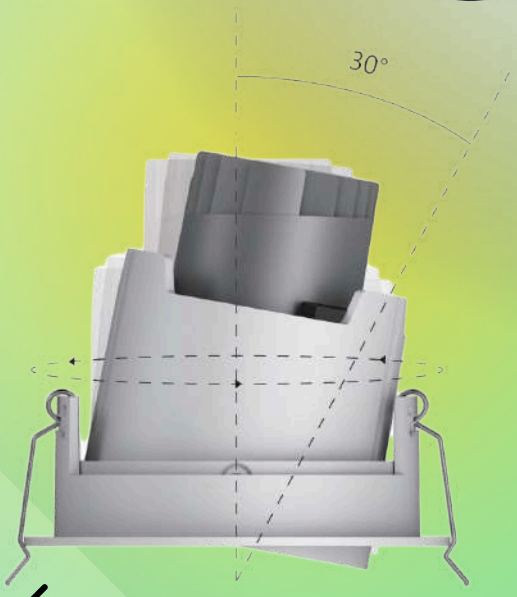

S
P
L
I
T
S
T
R
U
C
T
U
R
E

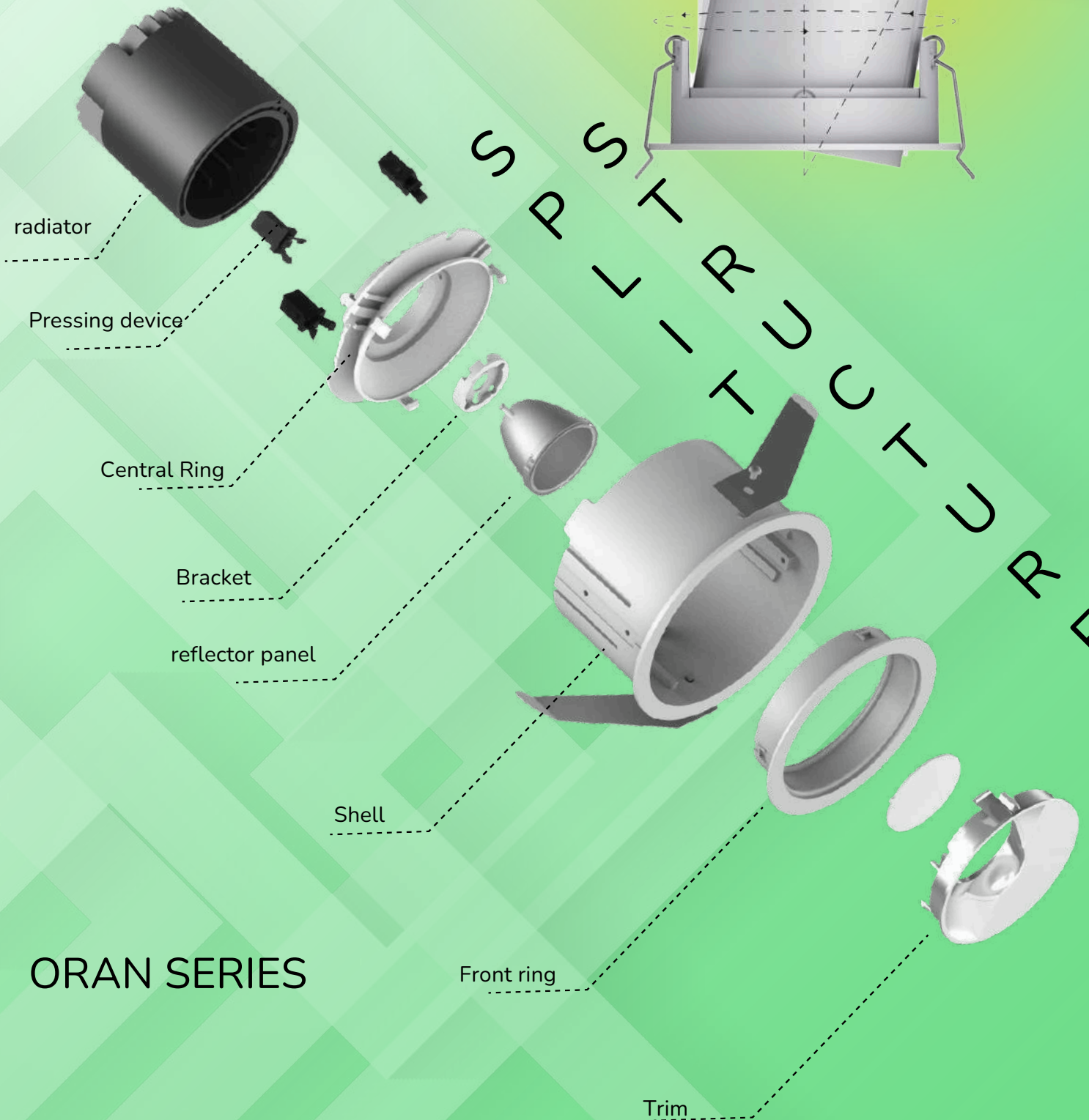

ORAN SERIES

MULTIPLE LIGHT DISTRIBUTION

ORAN SERIES

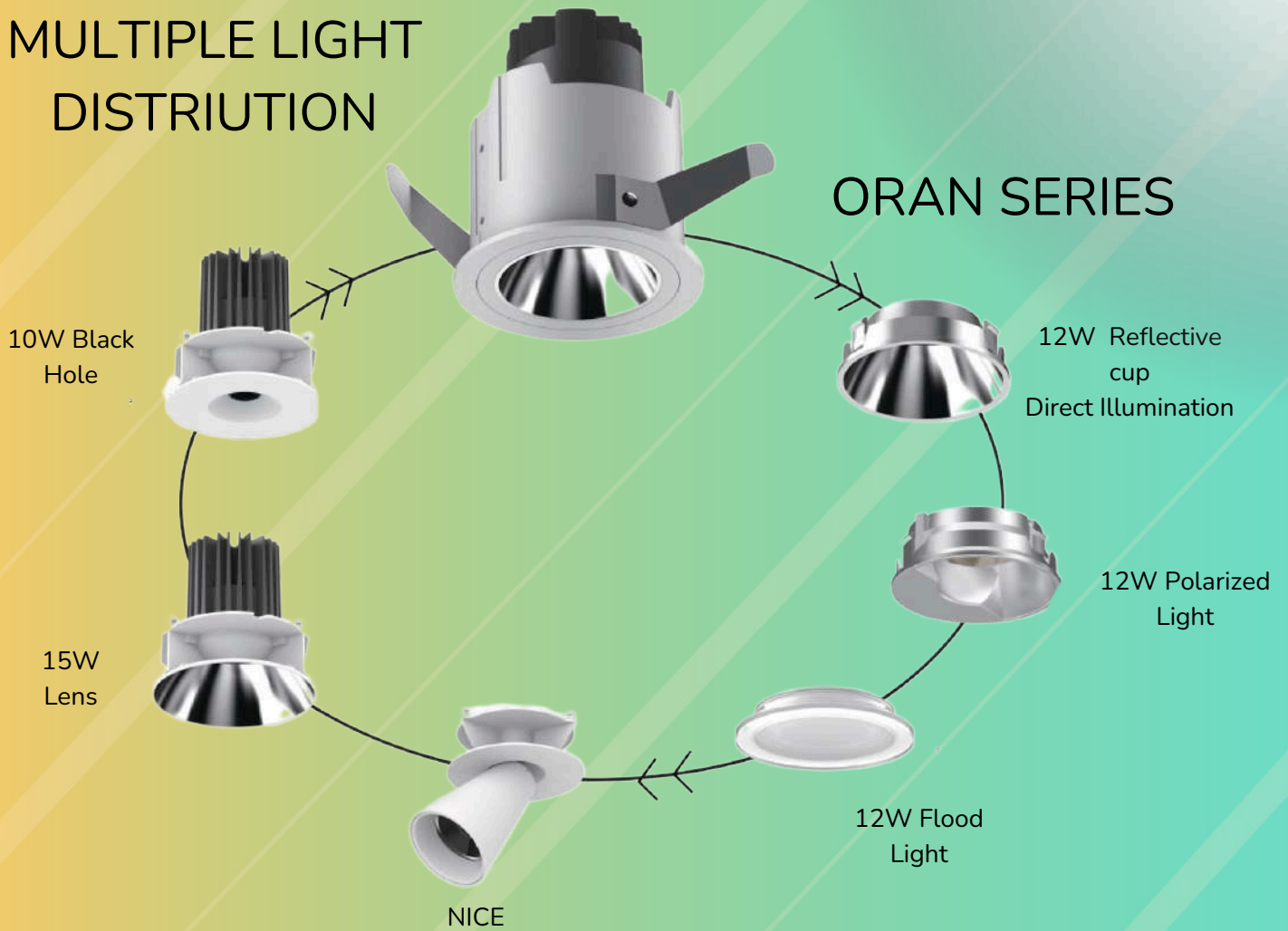

By modifying the optical path, it seamlessly adapts to diverse scene applications.

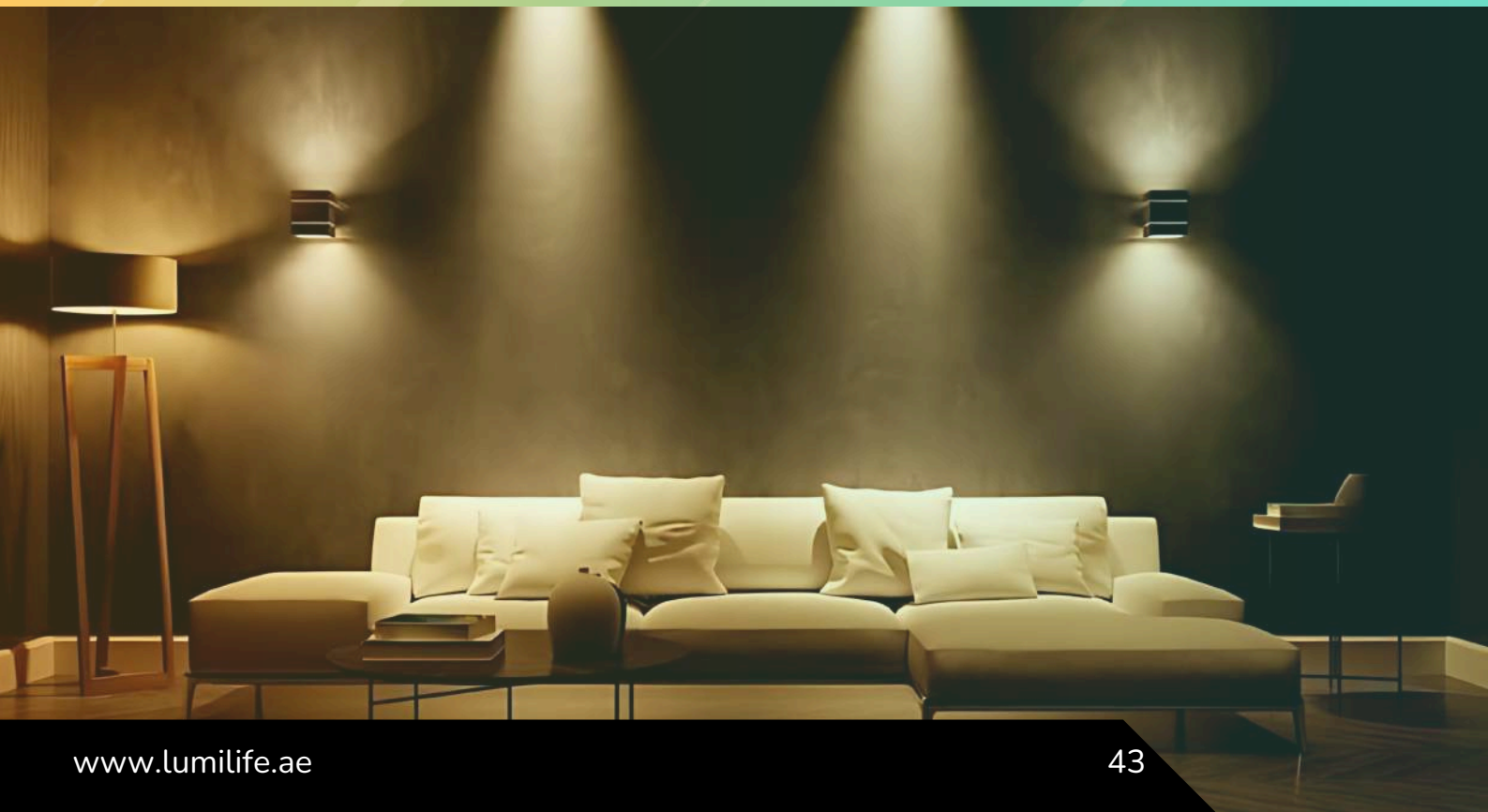

PHOEBE-SERIES



- The die-cast aluminum lamp body effectively resists corrosion and rust, enhances heat dissipation, and improves overall efficiency.
- Designed with IP43 anti-fog protection, it prevents fog and splashes from reaching the light source, making it ideal for use in kitchens and bathrooms.
- Features two optical structures: fixed direct lighting and adjustable oblique lighting for versatile applications.
- Equipped with an ultra-narrow beam angle, it ensures precise illumination from various angles to highlight the subject accurately.

2

ANTI-GLARE LIGHT

PHOEBE-SERIES

PHOEBE-SERIES ANTI-GLARE LIGHT

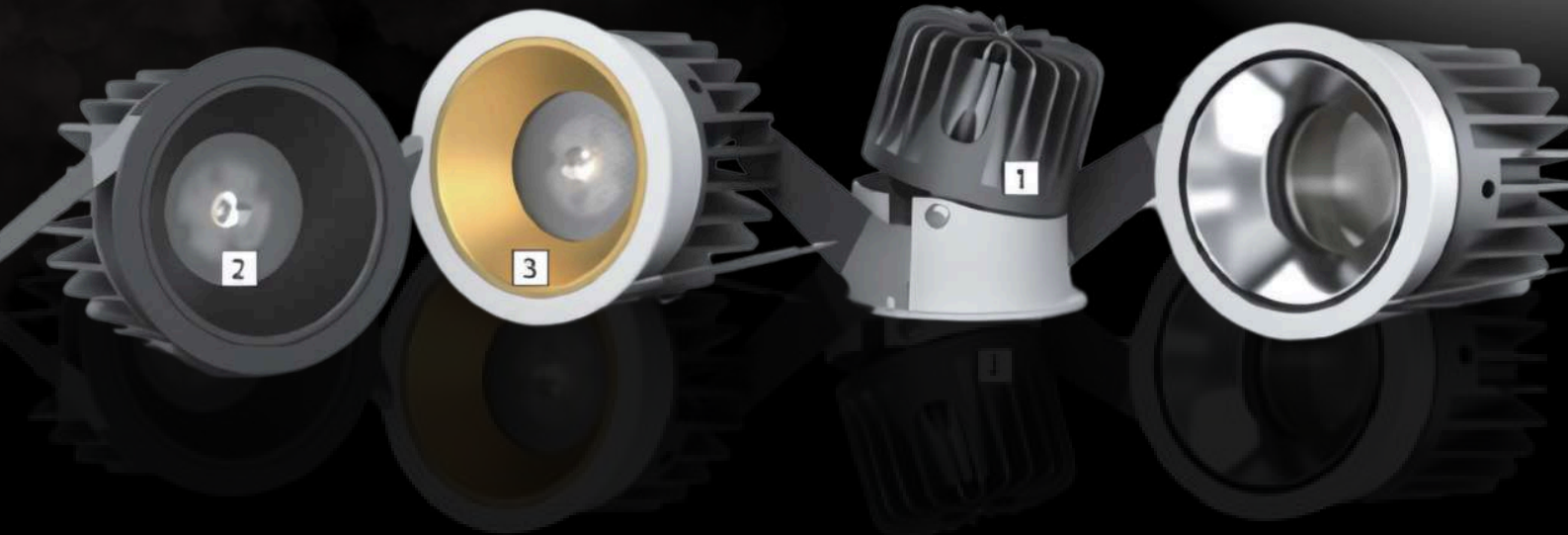

- 1** The adjustable lamp body (up to 16°) allows for precise angle customization, making on-site adjustments more convenient.
- 2** Can be paired with a honeycomb grid to minimize glare and prevent excessive light diffusion effectively
- 3** Reflectors in various colors can be selected to match the ceiling and complement the overall design of the space.

This series features a unique ultra-thin shell design, making it ideal for installation in ceilings with limited space and simplifying construction. Its luminous surface ensures even lighting with no dark spots, delivering a highly uniform and consistent light effect. These fixtures are perfect for large, open spaces that require reliable basic lighting

SEIRA-SERIES

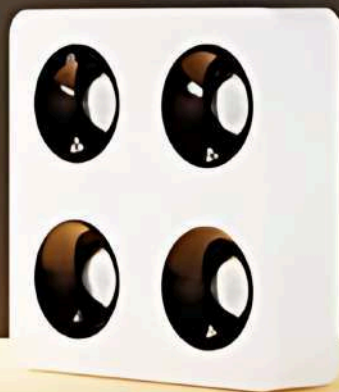
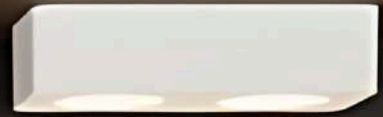

SANAA-SERIES



BEAM
ANGLE

120°



MAGNETIC LINEAR LIGHT





MAGNETIC FOLDING LIGHT

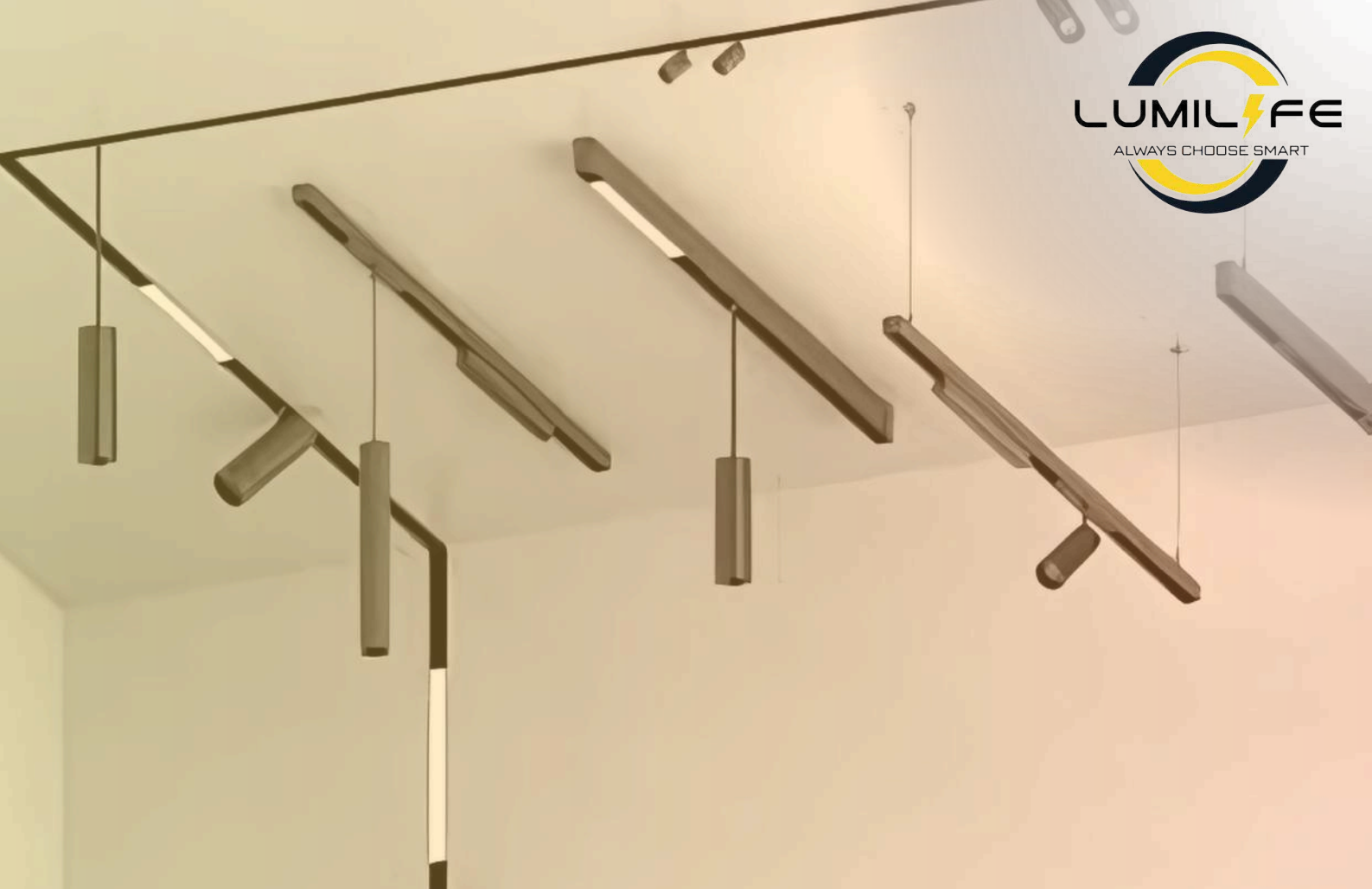

MAGNETIC SPOT LIGHT



MAGNETIC SUSPENSION LIGHT



MAGNETIC TRACK LIGHT



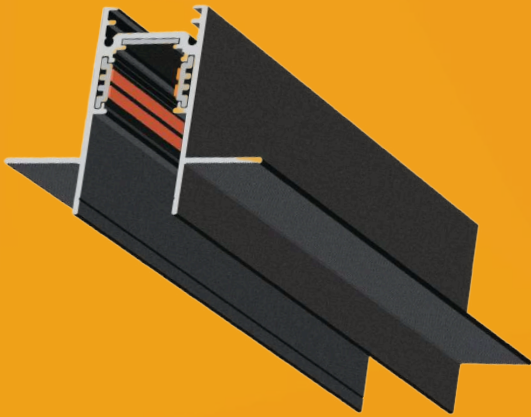

RECESSED MOUNT

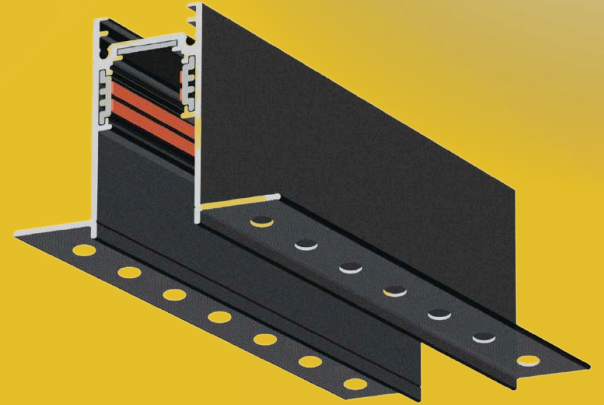

TRIMELESS
RECESSED MOUNT



90° HORIZONTAL ANGLE



90° VERTICAL ANGLE

MAGNETIC TRACK SYSTEM

ZIA-SERIES

WOVEN TRACK | ULTRA THIN LINEAR TRACK | FULL RANGE OF LAMPS

The whole Series and lamps can be matched to make the lighting space more flexible

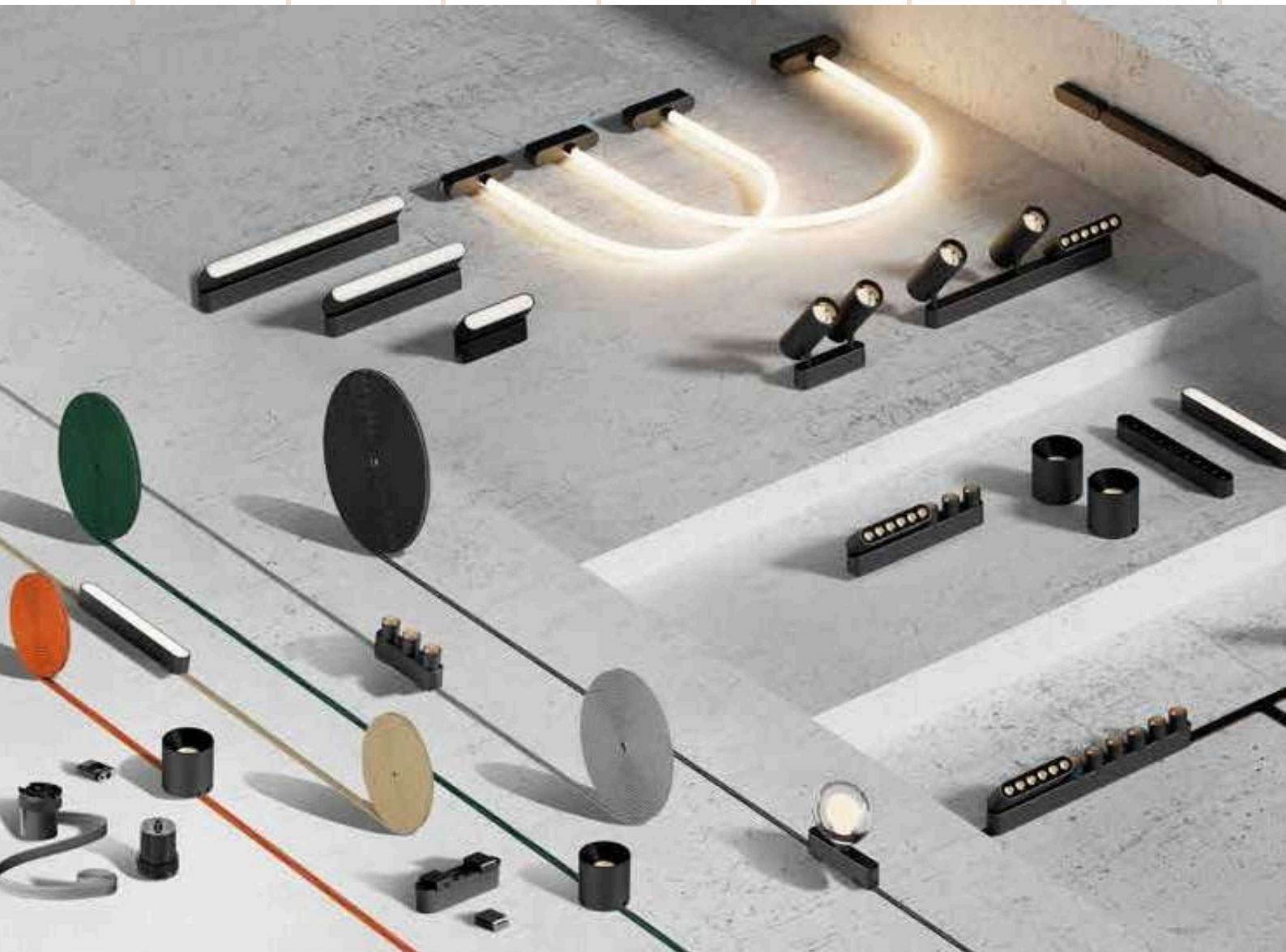

ZIA-SERIES

24V ULTRA THIN
LINEAR TRACK

Surface mounted track The Linear
Track is mini size 16*4.5mm

 Track can be cut arbitrarily

 The Lamp have safety locks

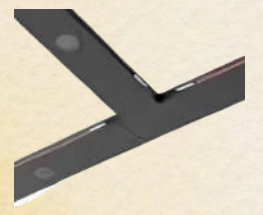
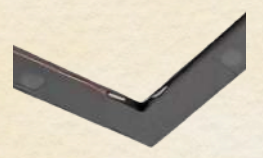
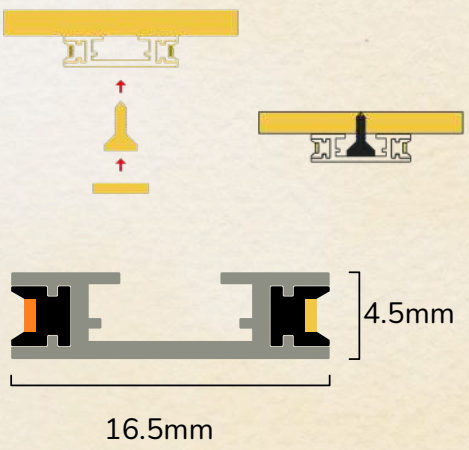



ULTRA THIN LINEAR TRACK and WOVEN TRACK

can be combined and used together Choose your preferred installation option according to your needs.

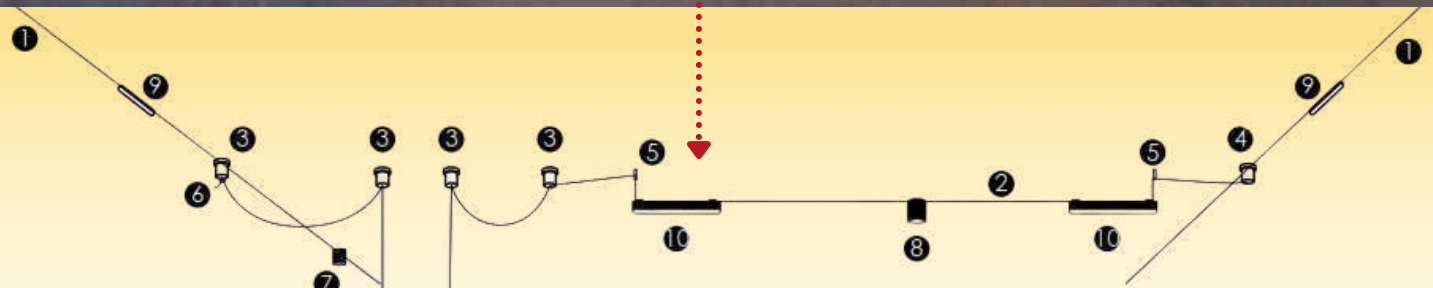

ZIA-SERIES



1 Surface mounted track

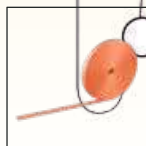

2 Woven track



5 Small fixed nodes



6 Woven buckle



3 Large fixed nodes



4 Large fixed nodes + Woven track input module



7 Surface mounted spotlights



8 Surface mounted spotlights + Woven track Linker * 2pcs



9 Floodlight light



10 Floodlight light + Woven track Linker * 2pcs

DAFFODILS SERIES



DAFFODILS decorative lights blend seamlessly with nature, designed to enhance outdoor spaces while preserving the ecosystem. Available in sand black and sand white finishes, with varying heights and surface designs, these lights feature hidden LEDs within high-quality acrylic. DAFFODILS provide warm, ambient lighting and natural decor for any outdoor environment

Accentuating the façade, putting the garden into the right light, and ensuring that paths remain visible even in the dark - modern outdoor lights are real all-rounders. Simply select your favorite lights and start planning.

Garden bollard lights are characterized by perfect uniformity of light all around, which is an essential and compact garden bollard family available to choose from.

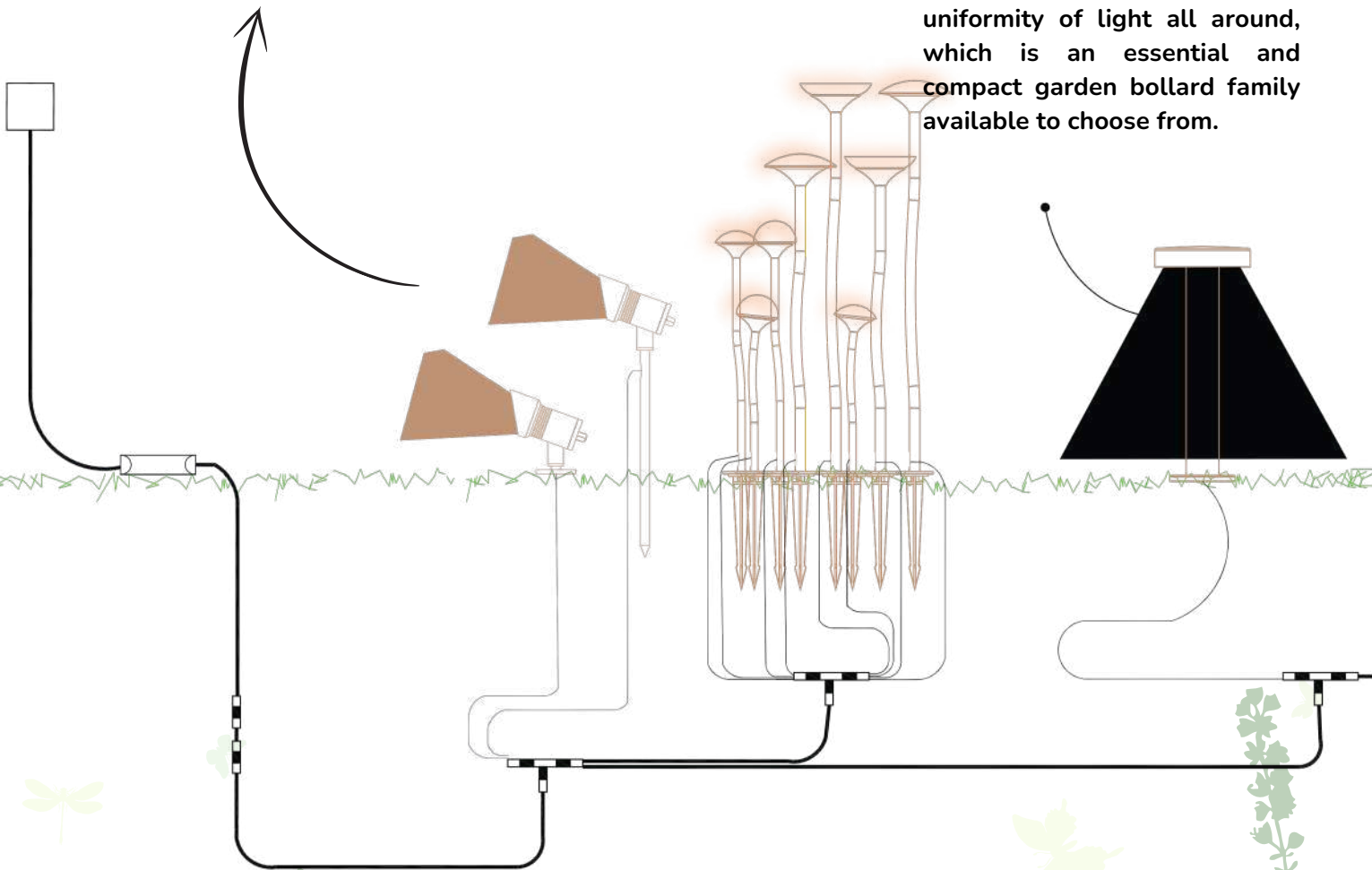

Garden decorative lights are particularly easy to install with a DC24V transformer. Several lights are available in different shapes, offering various lighting effects in different applications. Two, three, four, or even more, the choice is yours!



DANDELION offers versatile, eco-friendly lighting that highlights greenery and architecture with minimal impact. Inspired by the dandelion shape, its LED core mimics pistils and stamens, casting soft halos to illuminate walls, hedges, and trees. Perfect for enhancing details while evoking timeless emotions.

DANDELION SERIES



STICK SERIES IP65





MUSHROOM SERIES

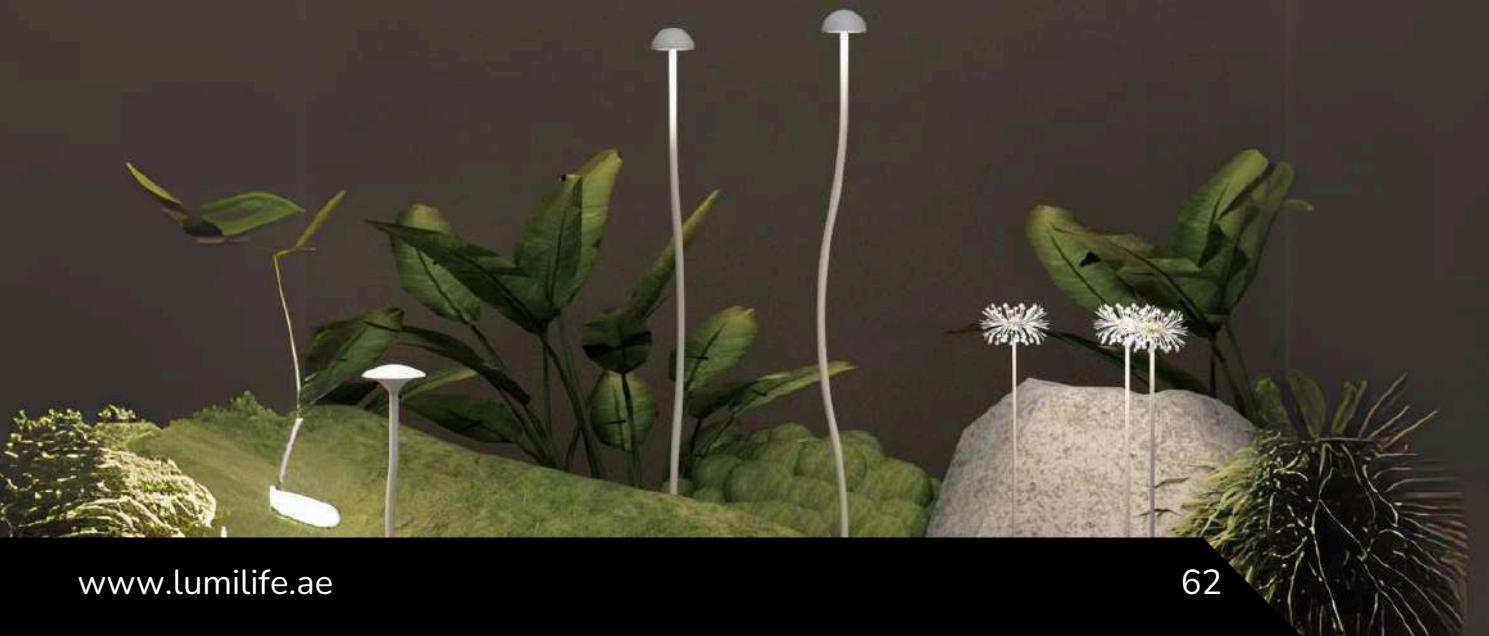

OLINDIAS SERIES

The OLINDIAS lamp series combines artistic charm with functionality, transforming courtyards into enchanting spaces. More than just lighting, these lamps are art pieces that illuminate while enhancing the garden's beauty. They symbolize a refined lifestyle, attention to detail, and add an elegant ambiance to your outdoor spaces.

THANK YOU...

Thank you for exploring **Lumilife**'s catalog of innovative lighting solutions. We are committed to illuminating your spaces with products that combine quality, efficiency, and style. Your trust and satisfaction inspire us to continue delivering excellence. Let **Lumilife** brighten your world

LUMILIFE LIGHTING & ELECTRICAL LLC. ALWAYS CHOOSE SMART

www.lumilife.ae



Office Address

1904,19TH Floor,
Palace Towers,
Silicon Oasis,
Dubai, UAE.

Follow us On:



www.lumilife.ae



Info@lumilife.ae



[Lumilife.ae](https://www.instagram.com/lumilife.ae)



[Lumilife lighting & Electrical LLC.](https://www.linkedin.com/company/lumilife-lighting-&-electrical-llc)

Our Other Services:

Home Automation | Electricals | Solar | ELV