

www.lumilife.ae

**ALWAYS
CHOOSE SMART**

LED LIGHTING CATALOG

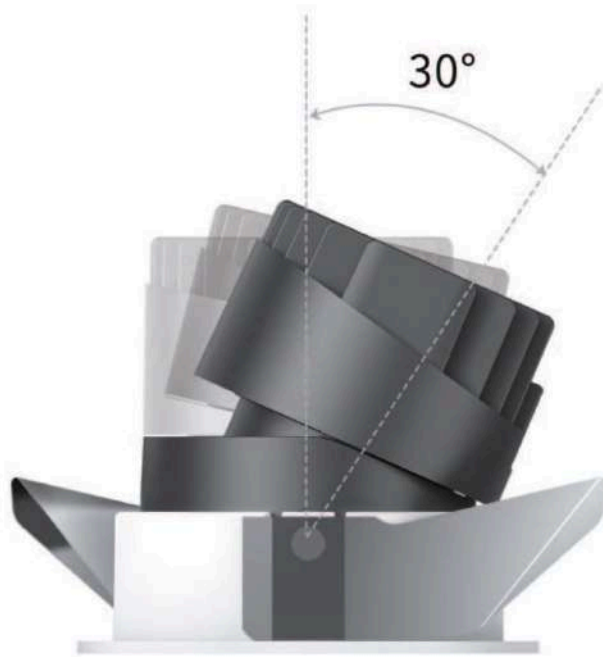



0~30°

Stepless regulation 0~30° at any angle



355°

Positioning groove 355° Horizontal rotation

Horizontal rotation of 355°, with positioning point, damping to Fool-proof and prevent winding.

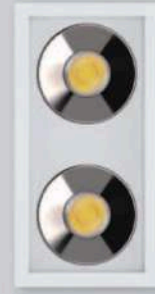

Everything

Circular / Square / brimless

4 variety of styles and lighting effects can be selected according to the lighting effect and surface ring. Each face ring has its own unique light effect





Linan round Edged

NEW Model: XQ-100301E55
 Power: 8W
 Beam angle: 15° / 24° / 36° / 55°
 Cutout: Ø55mm
 Size(WxH): Ø63x76mm / Ø63x78mm
 Standard holder: **CREE** 1304

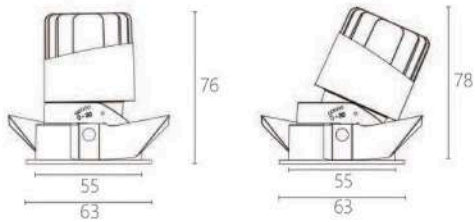

Reflector cover:



Adjustable
XQ100302E55



Round beam
XQ100303E55

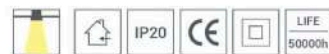

Holistic Trimless Fixed

NEW Model: XQ-100301T55-YT
 Power: 8W
 Beam angle: 15° / 24° / 36° / 55°
 Cutout: Ø55mm
 Size(WxH): Ø86x76mm / Ø86x78mm
 Standard holder: **CREE** 1304

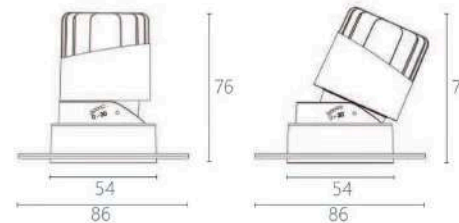

Reflector cover:



Adjustable
XQ100302T55-YT



Holistic Trimless Round beam
XQ100303T55-YT





Linan square Edged single head



Linan square Edged double head



Linan square Edged three head



Linan Square Trimless single head



Linan Square Trimless double head



Linan Square Trimless three head

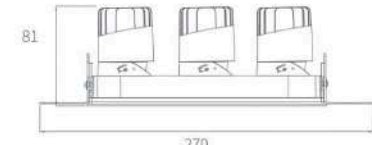
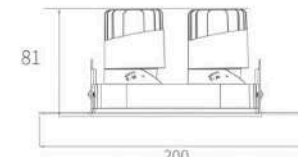
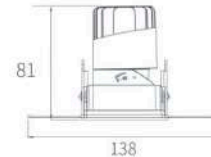
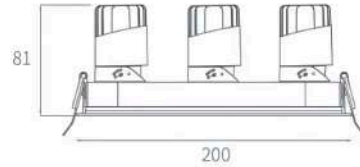
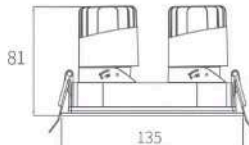
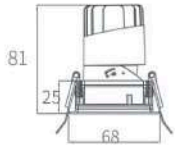

NEW Model: XQ- 100302P55

Power: 8W

Beam angle: 15° / 24° / 36° / 55°

Cutout: 60X60 mm

Size(WxH): 68X68X81mm

Standard holder: **CREE** 1304

NEW Model: XQ- 100302P55-2

Power: 2x8W

Beam angle: 15° / 24° / 36° / 55°

Cutout: 130X60mm

Size(WxH): 135X68X81mm

Standard holder: **CREE** 1304

NEW Model: XQ- 100302P55-3

Power: 3x8W

Beam angle: 15° / 24° / 36° / 55°

Cutout: 196x60mm

Size(WxH): 200X68X81mm

Standard holder: **CREE** 1304

NEW Model: XQ- 100302PT55

Power: 8W

Beam angle: 15° / 24° / 36° / 55°

Cutout: 62 X60 mm

Size(WxH): 138X68X81mm

Standard holder: **CREE** 1304

NEW Model: XQ- 100302PT55-2

Power: 2x8W

Beam angle: 15° / 24° / 36° / 55°

Cutout: 132X60mm

Size(WxH): 200X68X81mm

Standard holder: **CREE** 1304

NEW Model: XQ- 100302PT55-3

Power: 3x8W

Beam angle: 15° / 24° / 36° / 55°

Cutout: 198x60mm

Size(WxH): 270X68X81mm

Standard holder: **CREE** 1304

Reflector cover:



Reflector cover:





Linan round Edged

NEW Model: XQ-100301E65s-JS
 Power: 10W
 Beam angle: 15° / 24° / 36° / 55°
 Cutout: Ø65mm
 Size(WxH): Ø72.5x72mm / Ø72.5x75mm
 Standard holder: **CREE** 1304

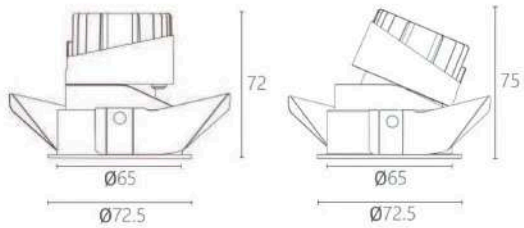

Reflector cover:



Adjustable
 XQ100302E65s-JS



Round beam
 XQ100303E65s-JS



Holistic Trimless Fixed

NEW Model: XQ-100301T65s-YT-JS
 Power: 10W
 Beam angle: 15° / 24° / 36° / 55°
 Cutout: Ø65mm
 Size(WxH): Ø98x72mm / Ø98x75mm
 Standard holder: **CREE** 1304

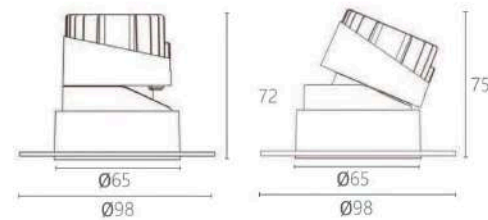

Reflector cover:



Adjustable
 XQ100302T65s-YT-JS



Holistic Trimless Round beam
 XQ100303T65s-YT-JS





Beauty, more than one

The reflector is available in 6 colors to meet the needs of different occasions

The reflector is precisely designed, electroplated and nano spray painted

Comfortable light type with high reflection efficiency and high efficiency



Linan series
Power: 6W



Fixed

Model: XQ-100301E50
Power: 6W
Beam angle: 10° / 15° / 24° / 36°
Cutout: Ø50mm
Size(WxLxH): 58x73mm
Standard holder: **CREE** 1304

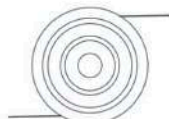
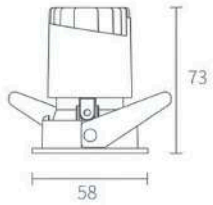

Adjustable
XQ-100302E50



round beam
XQ-100303E50



Oval beam
XQ-100304E50



Trimless Fixed

Model: XQ-100301T50
Power: 6W
Beam angle: 10° / 15° / 24° / 36°
Cutout: Ø52mm
Size(WxLxH): 97x73mm
Standard holder: **CREE** 1304

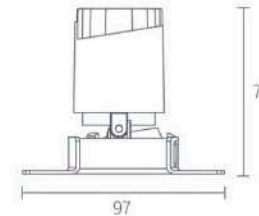

Trimless Adjustable
XQ-100302T50



Trimless Round beam
XQ-100303T50



Trimless Oval beam
XQ-100304T50



Linan series
Power: 6W



Fixed

Model: XQ-100301P50

Power: 6W

Beam angle: 10° / 15° / 24° / 36°

Cutout: Ø50mm

Size(WxLxH): 60x60x73mm

Standard holder: **CREE** 1304

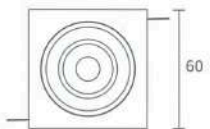
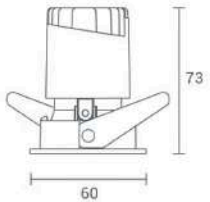

Adjustable
XQ-100302P50



round beam
XQ-100303P50



Oval beam
XQ-100304P50



Trimless Fixed

Model: XQ-100301E55

Power: 6W

Beam angle: 10° / 15° / 24° / 36°

Cutout: Ø50mm

Size(WxLxH): Ø65x73mm

Standard holder: **CREE** 1304

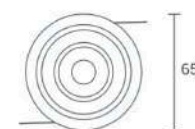
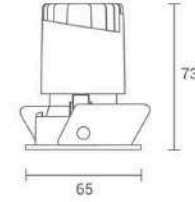

Trimless Adjustable
XQ-100302E55



Trimless Round beam
XQ-100303E55



Trimless Oval beam
XQ-100304E55



Linan series
Power: 6W



Fixed

Model: XQ-100301E70
Power: 6W
Beam angle: 10° / 15°/24° / 36°
Cutout: Ø70mm
Size(WxH): Ø80x81mm
Standard holder: **CREE** 1304

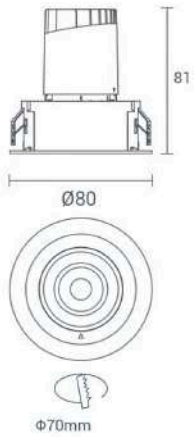

Adjustable
XQ-100802E70



round beam
XQ-100803E70



Oval beam
XQ-100304E70



Trimless Fixed

Model: XQ-100301T70
Power: 6W
Beam angle: 10° / 15°/24° / 36°
Cutout: Ø72.5mm
Size(WxH): 126x81mm
Standard holder: **CREE** 1304

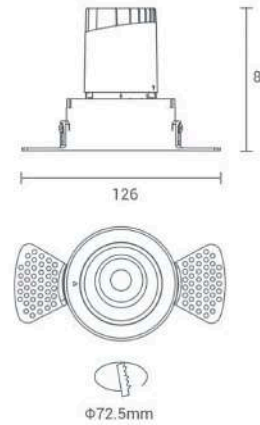

Trimless Adjustable
XQ-100302T70



Trimless Round beam
XQ-100303T70



Trimless Oval beam
XQ-100304T70



Linan series
Power: 6W



Holistic Trimless Fixed

Model: XQ-100302T50-YT
Power: 6W
Beam angle: 10° / 15°/24° / 36°
Cutout: Ø50mm
Size(WxH): Ø85x76mm
Standard holder: **CREE** 1304

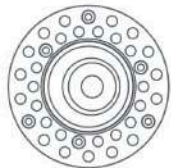
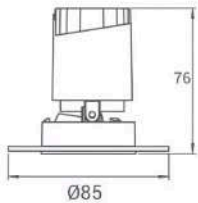

Holistic Trimless Adjustable
XQ-100302T50-YT



Holistic Trimless Round beam
XQ-100303T50-YT



Holistic Trimless Oval beam
XQ-100304T50-YT



Linan series
Power: 10W



Model: XQ-100302E65-10w(LENS)
Power: 10W
Beam angle: 10° / 15° / 24° / 36° / 55°(LENS)
Cutout: Ø65mm
Size(WxH): Ø72.5x81mm
Standard holder: **CREE** 1304
Optional holder: **CREE** 1507

Adjustable

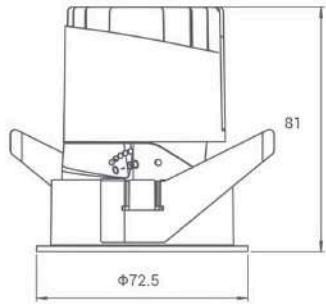

Model: Xq-100302T65-YT-10W (LENS)
Power: 10W
Beam angle: 10° / 15° / 24° / 36° / 55°(LENS)
Cutout: Ø65mm
Size(WxH): Ø98x81mm
Standard holder: **CREE** 1304
Optional holder: **CREE** 1507

Trimless Adjustable

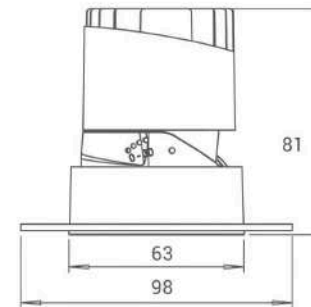

Reflect cover color choice:



Reflect cover color choice:



Linan series
Power: 12W



Model: XQ-100302E82(LENS)
Power: 12W
Beam angle: 10°/15°/24°/36°/55°
Rim Cutout: 82x82mm
Trimless Cutout: 82x79mm
Size(WxLxH): 89x89x110mm
Standard holder: **CREE** 1507
Optional holder: **CREE** 1304
LUMINUS CXM-6/7/9

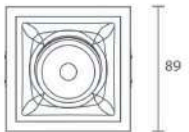
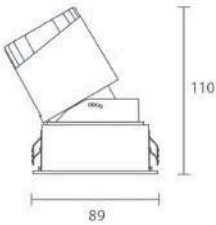

82x82mm



Square
XQ-100302E82-LENS



Square Trimless
XQ-100302T82-LENS



Square spot
XQ-100303E82-LENS



Square spot
XQ-100303T82-LENS



Model: XQ-100302E82-2-LENS
Power: 2X12W
Beam angle: 10°/15°/24°/36°/50°
Rim Cutout: 154x82.5mm
Trimless Cutout: 154x84.5mm
Size(WxLxH): 164x89x110mm
Standard holder: **CREE** 1507
Optional holder: **CREE** 1304
LUMINUS CXM-6/7/9

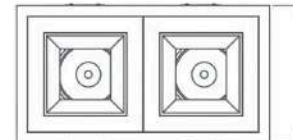
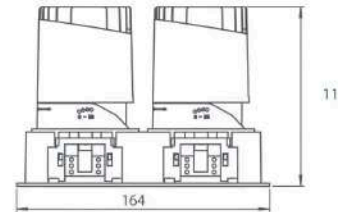

154x82.5mm



Square Double head
XQ-100302E82-2-LENS



Square Trimless Double head
XQ-100302T82-2-LENS



Double head Square spot
XQ-100303E82-2-LENS



Trimless Double head Square spot
XQ-100303T82-2-LENS



Linan series
Power: 20W



Fixed

Model: XQ-100301E95
Power: 20W
Beam angle: 12°/15°/24°/36°/60°
Cutout: Ø95mm
Size(WxH): Ø106x116mm
Standard holder: **CREE** 1507
Optional holder: **CREE** 1304
LUMINUS CXM-6/7/9

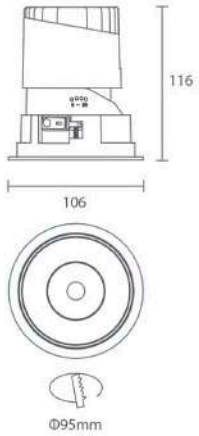

Adjustable
XQ-100302E95



round beam
XQ-100303E95



Oval beam
XQ-100304E95



Anti-glare
XQ-100305E95



Trimless Fixed

Model: XQ-100301T95
Power: 20W
Beam angle: 12°/15°/24°/36°/60°
Cutout: Ø96mm
Size(WxH): 162x116mm
Standard holder: **CREE** 1507
Optional holder: **CREE** 1304
LUMINUS CXM-6/7/9

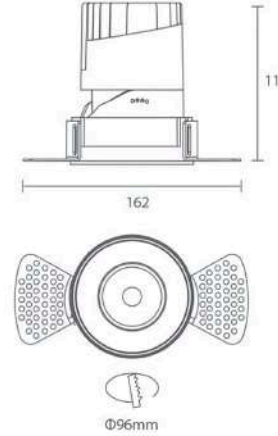

Trimless Adjustable
XQ-100302T95



Trimless round beam
XQ-100303T95



Trimless Oval beam
XQ-100304T95



Trimless Anti-glare
XQ-100305T95



Linan series
Power: 30W



Fixed

Model: XQ-100301E120

Power: 30W

Beam angle: 10°/15°/24°/36°

Cutout: Ø120mm

Size(WxH): Ø132x145mm

Standard holder: **CREE** 1816

Optional holder: **CREE** 1830

LUMINUS CXM-14

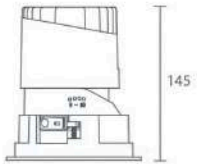

132



Ø120mm



Fixed

XQ-100301E120



Adjustable

XQ-100302E120



Anti-glare

XQ-100305E120



Trimless Fixed

Model: XQ-100301T120

Power: 30W

Beam angle: 10°/15°/24°/36°

Cutout: Ø120mm

Size(WxH): 185x145mm

Standard holder: **CREE** 1816

Optional holder: **CREE** 1830

LUMINUS CXM-14

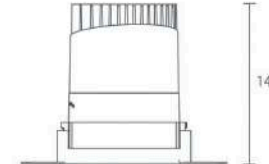

185

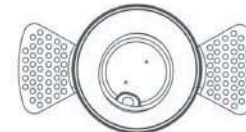

Ø120mm



Trimless Fixed
XQ-100301T120



Trimless Adjustable
XQ-100302T120



Trimless Anti-glare
XQ-100305T120



Stella

New Series Coming on in 2023



Cool and fashionable bright colors Matching urban aesthetics
Mix and match the fashion atmosphere to attack the front line of style.
Their color confrontation and collision can express the meaning that is difficult to express

Convenient adjustment
Can be rotated to all angles



Pragmatism, ingenious details



Stepless regulation 0~30° at any angle



4 kinds of frame can be selected

Four kinds of frame can be selected:
round, integral trimless, square single head, square double head



Available in 6 colors Suitable for different decoration environments

The reflector is precisely designed with electroplating (anti UV) and nano paint technology, which is suitable for different soft decoration environments

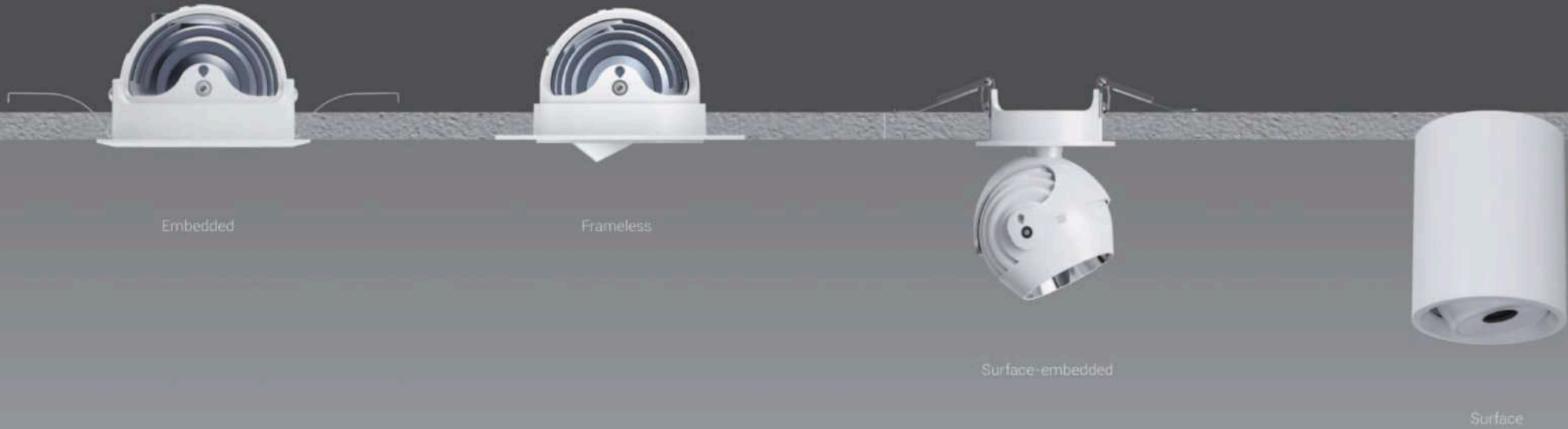

Installation Method

The installation method can be embedded, trimless, surface-embedded and surface

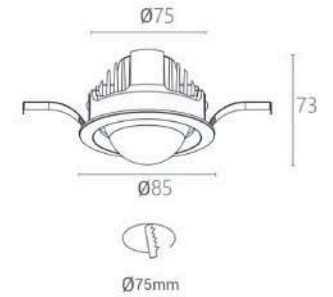
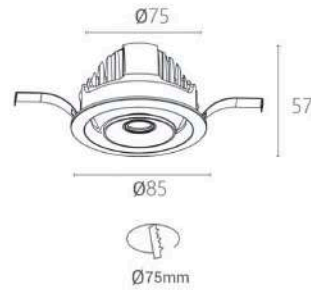
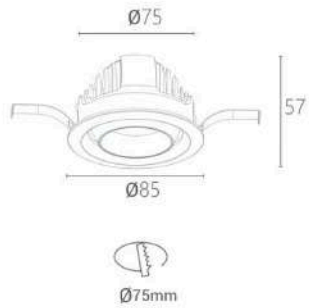

NEW Model: XQ-1001E75-PK-LENS

Power: 12W
 Cutout: Ø75mm
 Size(WxH): Ø85X57mm
 Beam angle: 15°/24°/36°/50°
 Standard holder: **CREE** 1507
 Optional holder: **CREE** 1304
LUMINUS CXM-6 CXM-9

NEW Model: XQ-1001E75-HD

Power: 12W
 Cutout: Ø75mm
 Size(WxH): Ø85X57mm
 Beam angle: 24°/36°
 Standard holder: **Shinlun** V4HD

NEW Model: XQ-1001E75-ZY

Power: 12W
 Cutout: Ø75mm
 Size(WxH): Ø85X70mm
 Beam angle: 15°/24°/36°/50°
 Standard holder: **CREE** 1507
 Optional holder: **CREE** 1304
LUMINUS CXM-6 CXM-9

NEW Model: XQ-1001E75-FG

Power: 12W
 Cutout: Ø75mm
 Size(WxH): Ø85X73mm
 Beam angle: 60°
 Standard holder: **CREE** 1507
 Optional holder: **CREE** 1304
LUMINUS CXM-6 CXM-9



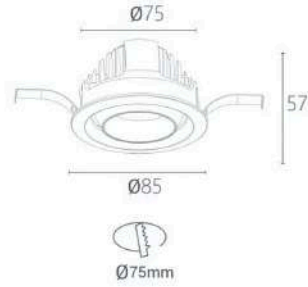
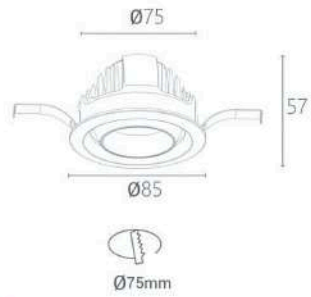

NEW Model: XQ-1001P75-PK-LENS
 Power: 12W
 Cutout: 75x75mm
 Size(WxH): 85X62mm
 Beam angle: 15°/24°/36°/50°
 Standard holder: **CREE** 1507
 Optional holder: **CREE** 1304
LUMINUS CXM-6 CXM-9

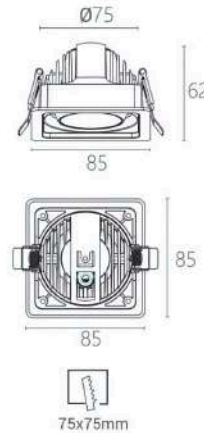

BlackHole Type



Snout Type



Acrylic Type



Reflector Cup Type



Focusing Type

NEW Model: XQ-1001E75-PK-FGB
 Power: 12W
 Cutout: Ø75mm
 Size(WxH): Ø85X57mm
 Beam angle: 18°/24°/36°
 Standard holder: **CREE** 1507
 Optional holder: **CREE** 1304
LUMINUS CXM-6 CXM-9

NEW Model: XQ-1001E75-BJ-LENS
 Power: 12W
 Cutout: Ø75mm
 Size(WxH): Ø85X57mm
 Beam angle: 15°~50°
 Standard holder: **CREE** 1507
 Optional holder: **CREE** 1304
LUMINUS CXM-6 CXM-9





NEW Model: XQ-1001P75-PK-2
 Power: 12W
 Cutout: 150x75mm
 Size(WxH): 160x85XH62mm
 Beam angle: 15°/24°/36°/50°
 Standard holder: **CREE** 1507
 Optional holder: **CREE** 1304
LUMINUS CXM-6 CXM-9

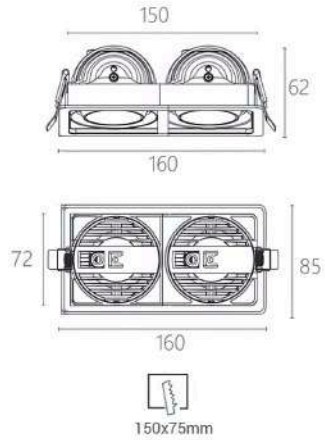

BlackHole Type



Snout Type



Acrylic Type



Reflector Cup Type



Focusing Type



NEW Model: XQ-1001E75-ZY-LENS
 Power: 12W
 Cutout: Ø55mm
 Size(WxH): Ø65X104mm
 Beam angle: 15°/24°/36°/50°
 Standard holder: **CREE** 1507
 Optional holder: **CREE** 1304
LUMINUS CXM-6 CXM-9

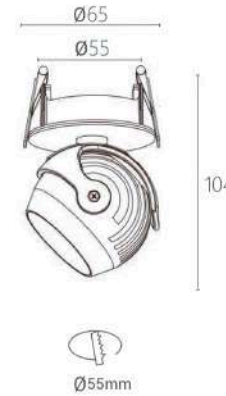

BlackHole Type



Snout Type



Acrylic Type



Reflector Cup Type



Focusing Type





Frameless

NEW Model: XQ-1001T75-PK
 Power: 12W
 Cutout: Ø75mm
 Size(WxH): Ø108X57mm
 Beam angle: 15°/24°/36°/50°
 Standard holder: **CREE** 1507
 Optional holder: **CREE** 1304
LUMINUS CXM-6 CXM-9

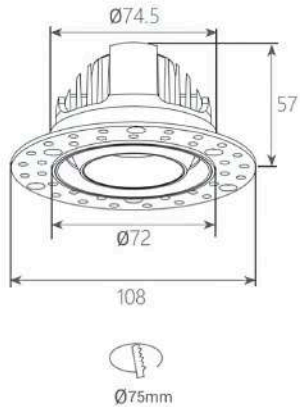

BlackHole Type



Snout Type



Acrylic Type



Reflector Cup Type



Focusing Type



Surface round

NEW Model: MZ7002R-ZZ10W
 Power: 12W
 Size(WxH): 77X100mm
 Beam angle: 15°/24°/36°/50°
 Standard holder: **CREE** 1507
 Optional holder: **CREE** 1304
LUMINUS CXM-6 CXM-9

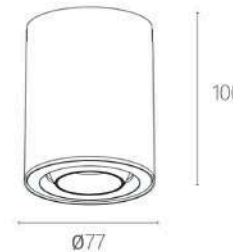

BlackHole Type



Snout Type



Acrylic Type



Reflector Cup Type



Focusing Type



SAIRA SERIES

IP65

Waterproof

Anti-glare

Multi-colours available

colour customisation supported

IP65

Waterproof

Not afraid of water/fog/oil/smoke can be used in the hotel, ballroom





NEW Model: XQ-1005E45
 Power: 6W
 Cutout: Ø45mm
 Size(WxH): Ø52X72mm
 Beam angle: 15°/24°/36°/55° (LENS)
 Beam angle: 18°/24°/38°(Reflector Cup)
 Waterproof: IP65 (LENS)
 Waterproof: IP40 (Reflector Cup)
 Standard holder: **CREE** 1304
 Optional holder: **CREE** 1306
 CXM-6

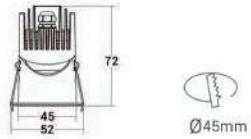

NEW Model: XQ-1005E65
 Power: 10W
 Cutout: Ø65mm
 Size(WxH): Ø73X80mm
 Beam angle: 10°/15°/24°/36°/55° (LENS)
 Beam angle: 18°/24°/38°(Reflector Cup)
 Waterproof: IP65 (LENS)
 Waterproof: IP40 (Reflector Cup)
 Standard holder: **CREE** 1304
 Optional holder: **CREE** 1507
 CXM-6

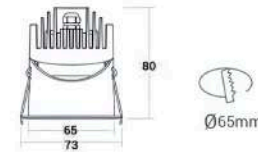

NEW Model: XQ-1005E55
 Power: 8W
 Cutout: Ø55mm
 Size(WxH): Ø62X77mm
 Beam angle: 10°/15°/24°/36°/55° (LENS)
 Beam angle: 18°/24°/38°(Reflector Cup)
 Waterproof: IP65 (LENS)
 Waterproof: IP40 (Reflector Cup)
 Standard holder: **CREE** 1304
 Optional holder: **CREE** 1306
 CXM-6

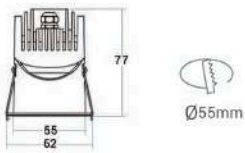

NEW Model: XQ-1005E75
 Power: 12W
 Cutout: Ø75mm
 Size(WxH): Ø84X85mm
 Beam angle: 10°/15°/24°/36°/55° (LENS)
 Beam angle: 18°/24°/38° (Reflector Cup)
 Waterproof: IP65 (LENS)
 Waterproof: IP40 (Reflector Cup)
 Standard holder: **CREE** 1304
 Optional holder: **CREE** 1507
 CXM-6

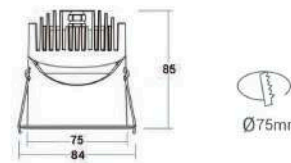

Reflector cover:

Optional:



Reflector cover:

Optional:





Excellent design

From its design proposal, to optical structure and heat dissipation structure, to product surface treatment
It embodies its uniqueness everywhere.

TIANYUE

Functional configuration applicable to multiple scenarios of full-featured product series

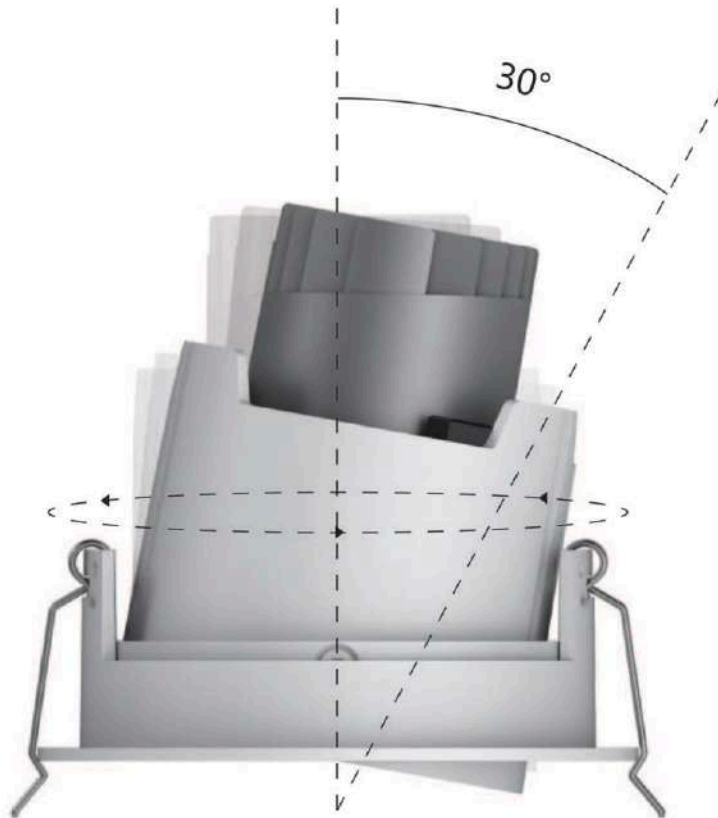

Large angle swing angle

Multi direction, multi angle swing angle, free choice of angle

The maximum angle is 30°



Multiple light distribution

By replacing the optical parts, the purpose of multi-scene application can be achieved

Power:6W



Model: DRE0406W
 Power: 6W
 Cutout : Ø70mm
 Size(WxLxH): Ø75X83mm
 Beam Angle: 15°/24°/38°
 Standard holder: **CREE** 1304
 Standard holder: **ITILED** 020

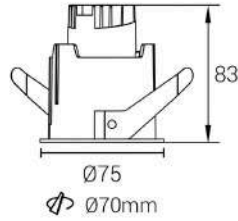

Model: DRE0406W
 Power: 6W
 Cutout : Ø85mm
 Size(WxLxH): Ø93X83mm
 Beam Angle: 15°/24°/38°
 Standard holder: **CREE** 1304
 Standard holder: **ITILED** 020

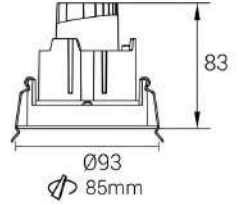

Direct
DRE0206W



Polarizer
PRE0206W



Acrylic
FRE0206W



Adjustable Direct
DRE0406W



Adjustable polarizer
PRE0406W



Model: DSE0206W
 Power: 6W
 Cutout : 60X60mm
 Size(WxLxH): 70X70X83mm
 Beam Angle: 15°/24°/38°
 Standard holder: **CREE** 1304
 Standard holder: **ITILED** 020

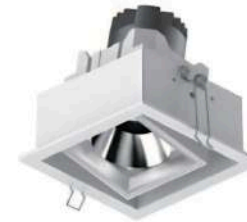
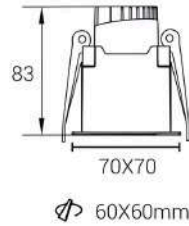

Model: DSE0406W
 Power: 6W
 Cutout : 82X82mm
 Size(WxLxH): 90X90X84mm
 Beam Angle: 15°/24°/38°
 Standard holder: **CREE** 1304
 Standard holder: **ITILED** 020

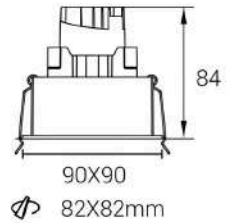

Direct
DSE0206W



Polarizer
PSE0206W



Acrylic
FSE0206W



Adjustable Direct
DSE0406W



Adjustable polarizer
PSE0406W

Power:6W



Model: DRT0206W
 Power: 6W
 Cutout : Ø70mm
 Size(WxLxH): Ø65X83mm
 Beam Angle:15°/24°/38°
 Standard holder: **CREE** 1304
 Optional holder: **ITILED** 020

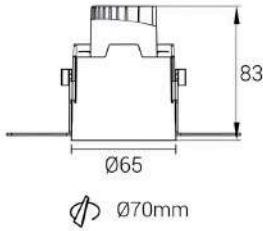

Model: DRT0406W
 Power: 6W
 Cutout : Ø85mm
 Size(WxLxH): Ø80X83mm
 Beam Angle:15°/24°/38°
 Standard holder: **CREE** 1304
 Optional holder: **ITILED** 020

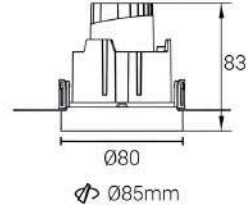

Direct
DRT0206W



Polarizer
PRT0206W



Acrylic
FRT0206W



Adjustable Direct
DRT0406W



Adjustable polarizer
PRT0406W



Model: DST0206W
 Power: 6W
 Cutout : 60*60mm
 Size(WxLxH):58X58X83mm
 Beam Angle:15°/24°/38°
 Standard holder: **CREE** 1304
 Optional holder: **ITILED** 020

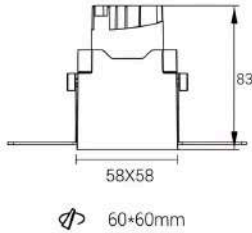

Model: DST0406W
 Power: 6W
 Cutout : 82X82mm
 Size(WxLxH):78X78X84mm
 Beam Angle: 15°/24°/38°
 Standard holder: **CREE** 1304
 Optional holder: **ITILED** 020

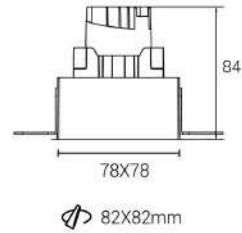

Direct
DST0206W



Polarizer
PST0206W



Acrylic
FST0206W



Adjustable Direct
DST0406W



Adjustable polarizer
PST0406W

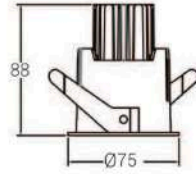

Ø 70mm

Model: DRE0210W-TJ
 Power: 10W
 Cutout : Ø70mm
 Size(WxLxH):Ø75X88mm
 Beam Angle:12°/24°/36°/55°
 Standard holder: **CREE** 1304
 Optional holder: **ITILED** 020

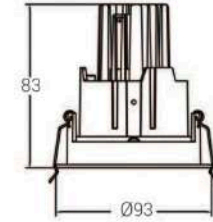

Ø 80mm

Model: DRE0410W-TJ
 Power: 10W
 Cutout : Ø80mm
 Size(WxLxH):Ø93X83mm
 Beam Angle:12°/24°/36°/55°
 Standard holder: **CREE** 1304
 Optional holder: **ITILED** 020

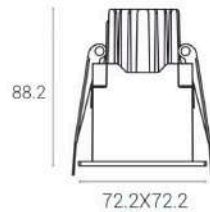

Ø 60X60mm

Model: DSE0210W-TJ
 Power: 10W
 Cutout : 60X60mm
 Size(WxLxH): 72.2X72.2X88.2mm
 Beam Angle: 12°/24°/36°/55°
 Standard holder: **CREE** 1304
 Optional holder: **ITILED** 020

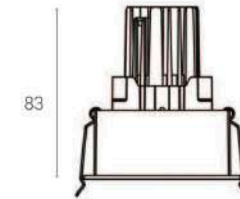

Ø 80x80mm

Model: DSE0410W-TJ
 Power: 10W
 Cutout : 80X80mm
 Size(WxLxH): 91X91X83mm
 Beam Angle:12°/24°/36°/55°
 Standard holder: **CREE** 1304
 Optional holder: **ITILED** 020

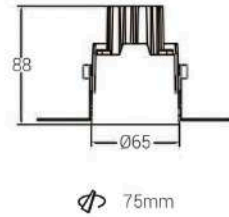

Model: DRT0210W-TJ
 Power: 10W
 Cutout : Ø75mm
 Size(WxLxH):Ø65X88mm
 Beam Angle:12°/24°/36°/55°
 Standard holder: **CREE** 1304
 Optional holder: **ITILED** 020

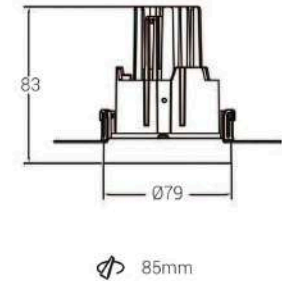

Model: DRT0410W-TJ
 Power: 10W
 Cutout : Ø85mm
 Size(WxLxH):Ø79X83mm
 Beam Angle:12°/24°/36°/55°
 Standard holder: **CREE** 1304
 Optional holder: **ITILED** 020

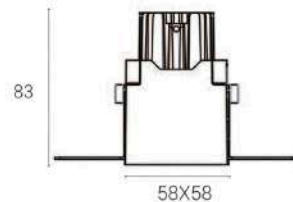

Model: DST0210W-TJ
 Power: 10W
 Cutout : 60X60mm
 Size(WxLxH):58X58X83mm
 Beam Angle: 12°/24°/36°/55°
 Standard holder: **CREE** 1304
 Optional holder: **ITILED** 020

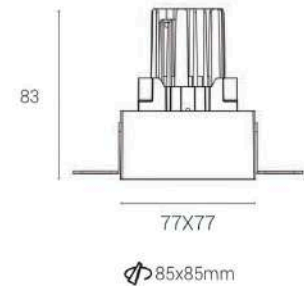

Model: DST0410W-TJ
 Power: 10W
 Cutout : 85X85mm
 Size(WxLxH):77X77X83mm
 Beam Angle: 12°/24°/36°/55°
 Standard holder: **CREE** 1304
 Optional holder: **ITILED** 020

TIANYUE series

Power:10W

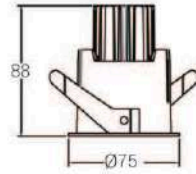

Ø 70mm

Model: DRE0210W-HD

Power: 10W

Cutout : Ø70mm

Size(WxLxH):Ø75X88mm

Beam Angle:24°/36°

Standard holder: **Shinlani** V4HD

Optional holder: **Shinlani** CXA13-HD

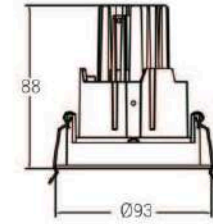

Ø 80mm

Model: DRE0410W-HD

Power: 10W

Cutout : Ø80mm

Size(WxLxH):Ø93X88mm

Beam Angle:24°/36°

Standard holder: **Shinlani** V4HD

Optional holder: **Shinlani** CXA13-HD

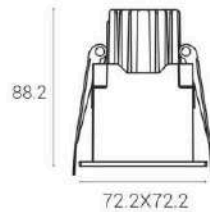

60X60mm

Model: DSE0210W-HD

Power: 10W

Cutout : 60X60mm

Size(WxLxH): 72.2X72.2X88.2mm

Beam Angle: 24°/36°

Standard holder: **Shinlani** V4HD

Optional holder: **Shinlani** CXA13-HD

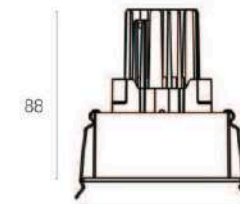

Ø80x80mm

Model: DSE0410W-HD

Power: 10W

Cutout : 80X80mm

Size(WxLxH): 91X91X88mm

Beam Angle: 24°/36°

Standard holder: **Shinlani** V4HD

Optional holder: **Shinlani** CXA13-HD



TIANYUE series

Power:10W

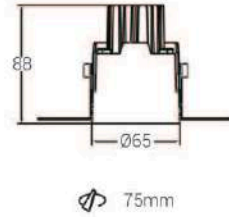

Model: DRT0210W-HD
Power: 10W
Cutout : Ø75mm
Size(WxLxH):Ø65X88mm
Beam Angle:24°/36°
Standard holder: **Shinlani** V4HD
Optional holder: **Shinlani** CXA13-HD

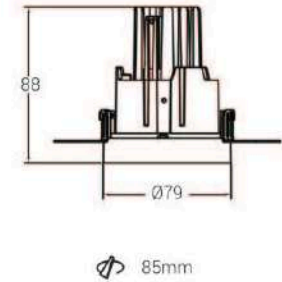

Model: DRT0410W-TJ
Power: 10W
Cutout : Ø85mm
Size(WxLxH):Ø79X88mm
Beam Angle:24°/36°
Standard holder: **Shinlani** V4HD
Optional holder: **Shinlani** CXA13-HD

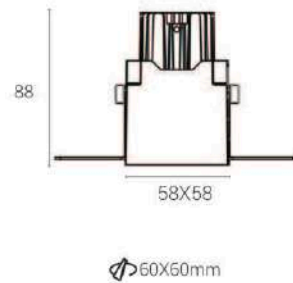

Model: DST0210W-HD
Power: 10W
Cutout : 60X60mm
Size(WxLxH): 58X58X88mm
Beam Angle: 24°/36°
Standard holder: **Shinlani** V4HD
Optional holder: **Shinlani** CXA13-HD

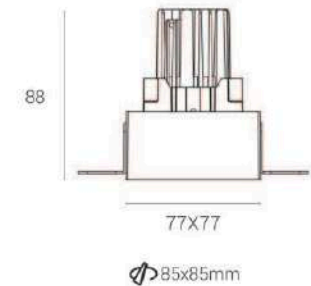

Model: DST0410W-HD
Power: 10W
Cutout : 85X85mm
Size(WxLxH):77X77X88mm
Beam Angle: 24°/36°
Standard holder: **Shinlani** V4HD
Optional holder: **Shinlani** CXA13-HD



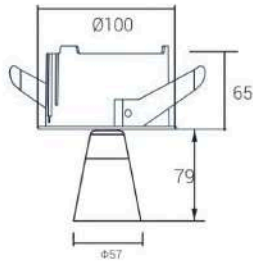

Ø94mm

Model: SRE-0210W-DLB
 Power: 10W
 Cutout : Ø94mm
 Size(WxLxH): Ø100X65X79mm
 Beam Angle: 15° /24°/38°
 Standard holder: **CREE** 1507
 Optional holder: **ITILED** 020

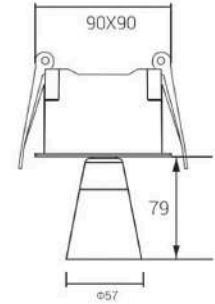

80X80mm

Model: SSE-0210W-DLB
 Power: 10W
 Cutout : 80x80mm
 Size(WxLxH):90X90x65mm
 Beam Angle: 15° /24°/38°
 Standard holder: **CREE** 1507
 Optional holder: **ITILED** 020

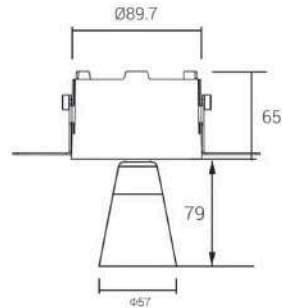

Ø95mm

Model: SRT-0210W-DLB
 Power:10W
 Cutout : Ø95mm
 Size(WxLxH):Ø89.7x65x79mm
 Beam Angle: 15° /24°/38°
 Standard holder: **CREE** 1507
 Optional holder: **ITILED** 020

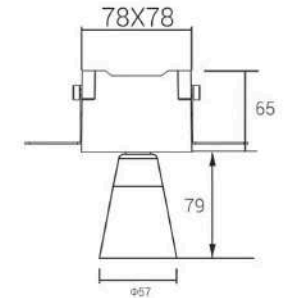

80X80mm

Model: SST-0210W-DLB
 Power:10W
 Cutout : 80x80mm
 Size(WxLxH):78x78x65mm
 Beam Angle: 15° /24°/38°
 Standard holder: **CREE** 1507
 Optional holder: **ITILED** 020

Power:12W



Model: DRE0212W
 Power: 12W
 Cutout : Ø94mm
 Size(WxLxH): Ø100X89.5mm
 Beam Angle: 15° /24°/38°
 Standard holder: **CREE** 1507
 Optional holder: **ITILED** 020

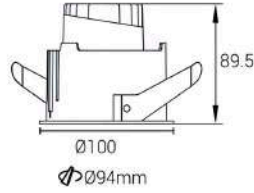

Model: DRE0412W
 Power: 12W
 Cutout : Ø110mm
 Size(WxLxH): Ø118X90mm
 Beam Angle: 15°/24°/38°
 Standard holder: **CREE** 1507
 Optional holder: **ITILED** 020

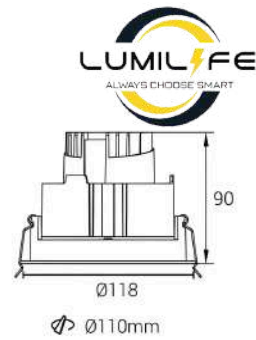

Direct
DRE0212W



Polarizer
PRE0212W



Acrylic
FRE0212W



Adjustable Direct
DRE0412W



Adjustable polarizer
PRE0412W



Model: DSE0212W
 Power:12W
 Cutout :80X80mm
 Size(WxLxH):90X90X90mm
 Beam Angle: 15° /24°/38°
 Standard holder: **CREE** 1507
 Optional holder: **ITILED** 020

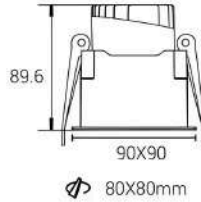

Model: DSE0412W
 Power:12W
 Cutout : 103X103mm
 Size(WxLxH):111X111X90mm
 Beam Angle: 15°/24°/38°
 Standard holder: **CREE** 1507
 Optional holder: **ITILED** 020

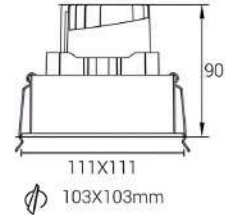

Direct
DSE0212W



Polarizer
PSE0212W



Acrylic
FSE0212W



Adjustable Direct
DSE0412W



Adjustable polarizer
PSE0412W

Power:12W



Model: DRT0212W
 Power: 12W
 Cutout :Ø95mm
 Size(WxLxH):Ø90X90mm
 Beam Angle: 15°/24°/38°
 Standard holder: **CREE** 1507
 Optional holder: **ITILED** 020

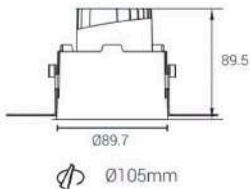

Model: DRT0412W
 Power: 12W
 Cutout : Ø110mm
 Size(WxLxH):Ø105X90mm
 Beam Angle: 15°/24°/38°
 Standard holder: **CREE** 1507
 Optional holder: **ITILED** 020

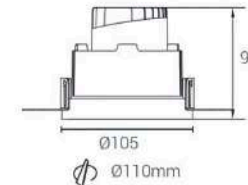

Direct
DRT0212W



Polarizer
PRT0212W



Acrylic
FRT0212W



Adjustable Direct
DRT0412W



Adjustable polarizer
PRT0412W



Model: DST0212W
 Power:12W
 Cutout : 80X80mm
 Size(WxLxH):78X78X90mm
 Beam Angle: 15°/24°/38°
 Standard holder: **CREE** 1507
 Optional holder: **ITILED** 020

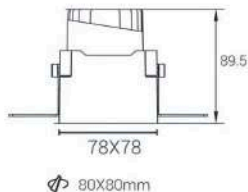

Model: DST0412W
 Power:12W
 Cutout : 103X103mm
 Size(WxLxH):99X99X90mm
 Beam Angle: 15°/24°/38°
 Standard holder: **CREE** 1507
 Optional holder: **ITILED** 020

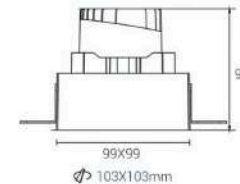

Direct
DST0212W



Polarizer
PST0212W



Acrylic
FST0212W



Adjustable Direct
DST0412W



Adjustable polarizer
PST0412W



TIANYUE series

Power:12W

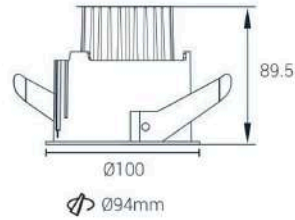

Model: DRE0212W-HD

Power: 12W

Cutout : Ø94mm

Size(WxLxH):Ø100X89.5mm

Beam Angle: 24°/36°

Standard holder: **Shinlani** V4HD

Optional holder: **Shinlani** CXA13-HD

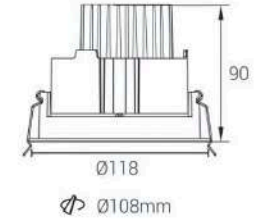

Model: DRE0412W-HD

Power: 12W

Cutout : Ø108mm

Size(WxLxH):Ø118X90mm

Beam Angle: 24°/36°

Standard holder: **Shinlani** V4HD

Optional holder: **Shinlani** CXA13-HD



Model: DSE0212W-HD

Power: 12W

Cutout : 80X80mm

Size(WxLxH):90X90X90mm

Beam Angle: 24°/36°

Standard holder: **Shinlani** V4HD

Optional holder: **Shinlani** CXA13-HD

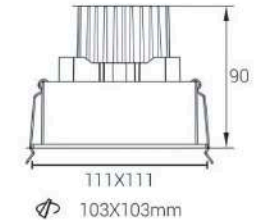

Model: DST0412W-HD

Power: 12W

Cutout : 103X103mm

Size(WxLxH):111X111X90mm

Beam Angle: 24°/36°

Standard holder: **Shinlani** V4HD

Optional holder: **Shinlani** CXA13-HD



TIANYUE series

Power:12W

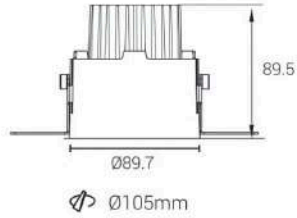

Model: DRT0212W-HD
 Power: 12W
 Cutout : Ø95mm
 Size(WxLxH): Ø89.7x89.5mm
 Beam Angle: 24°/36°
 Standard holder: **Shinlani** V4HD
 Optional holder: **Shinlani** CXA13-HD

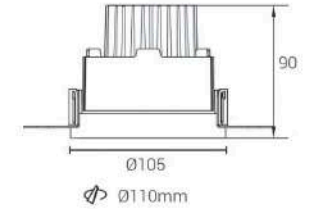

Model: DRT0412W-HD
 Power: 12W
 Cutout :Ø110mm
 Size(WxLxH):Ø105x90mm
 Beam Angle: 24°/36°
 Standard holder: **Shinlani** V4HD
 Optional holder: **Shinlani** CXA13-HD

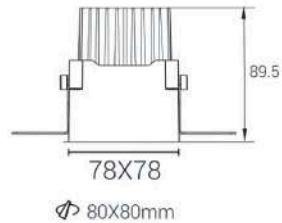

Model: DST0212W-HD
 Power:12W
 Cutout : Ø80X80mm
 Size(WxLxH):78x78x90mm
 Beam Angle: 24°/36°
 Standard holder: **Shinlani** V4HD
 Optional holder: **Shinlani** CXA13-HD

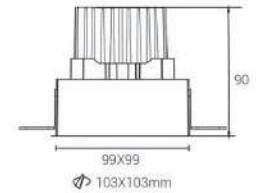

Model:DST0412W-HD
 Power:12W
 Cutout :103x103mm
 Size(WxLxH):99X99X90mm
 Beam Angle: 24°/36°
 Standard holder: **Shinlani** V4HD
 Optional holder: **Shinlani** CXA13-HD



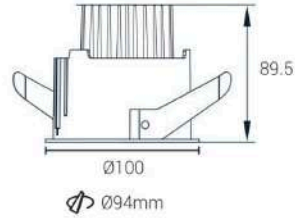

Model: DRE0216W-TJ
 Power: 16W
 Cutout : Ø94mm
 Size(WxLxH):Ø100X89.5mm
 Beam Angle: 12° / 24° / 36° / 55°
 Standard holder: **CREE** 1507
 Optional holder: **CREE** 1304

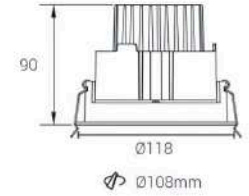

Model: DRE0416W- TJ
 Power: 16W
 Cutout : Ø108mm
 Size(WxLxH):Ø118X90mm
 Beam Angle: 12° / 24° / 36° / 55°
 Standard holder: **CREE** 1507
 Optional holder: **CREE** 1304

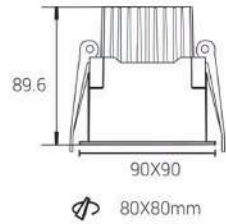

Model:DSE0216W-TJ
 Power:16W
 Cutout : 80x80mm
 Size(WxLxH):90X90X89.6mm
 Beam Angle: 12° / 24° / 36° / 55°
 Standard holder: **CREE** 1507
 Optional holder: **CREE** 1304

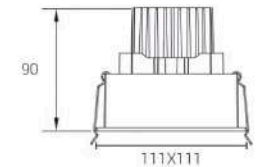

Model: DSE0416W-TJ
 Power: 16W
 Cutout : 80X80mm
 Size(WxLxH):111X111X90mm
 Beam Angle: 12° / 24° / 36° / 55°
 Standard holder: **CREE** 1507
 Optional holder: **CREE** 1304

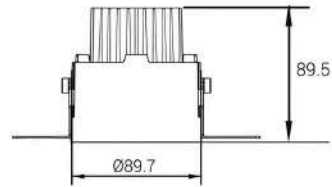

Ø105mm

Model: DRE0216W-TJ
 Power: 16W
 Cutout : Ø105mm
 Size(WxLxH):Ø89.5x89.7mm
 Beam Angle: 12° / 24° / 36° / 55°
 Standard holder: **CREE** 1507
 Optional holder: **CREE** 1304

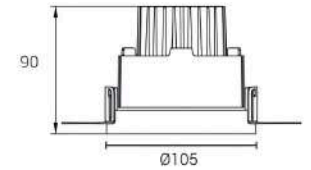

Ø108mm

Model: DRE0416W-TJ
 Power: 16W
 Cutout : Ø108mm
 Size(WxLxH):Ø105X90mm
 Beam Angle: 12° / 24° / 36° / 55°
 Standard holder: **CREE** 1507
 Optional holder: **CREE** 1304

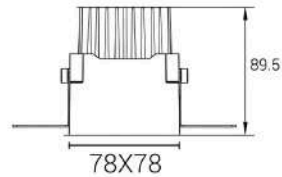

Ø80X80mm

Model: DST0216W-TJ
 Power:16W
 Cutout : 80x80mm
 Size(WxLxH):78x78x89.5mm
 Beam Angle: 12° / 24° / 36° / 55°
 Standard holder: **CREE** 1507
 Optional holder: **CREE** 1304

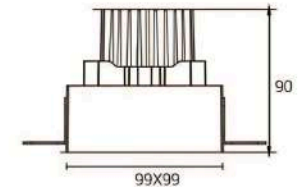

Ø103X103mm

Model: DST0416W-TJ
 Power: 16W
 Cutout : 103X103mm
 Size(WxLxH):99X99X90mm
 Beam Angle: 12° / 24° / 36° / 55°
 Standard holder: **CREE** 1507
 Optional holder: **CREE** 1304

Power:20W



Model: DRE0220W
 Power: 20W
 Cutout : Ø110mm
 Size(WxLxH): Ø117x132mm
 Beam Angle: 15°/24°/38°
 Standard holder: **CREE** 1507
 Optional holder: **ITILED** 020

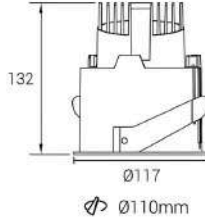

Model: DRE0420W
 Power: 20W
 Cutout : Ø125mm
 Size(WxLxH): Ø135x132mm
 Beam Angle: 15°/24°/38°
 Standard holder: **CREE** 1507
 Optional holder: **ITILED** 020

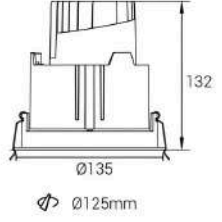

Direct
DRE0220W



Polarizer
PRE0220W



Acrylic
FRE0220W



Adjustable Direct
DRE0420W



Adjustable polarizer
PRE0420W



Model: DSE0220W
 Power: 20W
 Cutout : 100X100mm
 Size(WxLxH):110X110X132mm
 Beam Angle: 15°/24°/38°
 Standard holder: **CREE** 1507
 Optional holder: **ITILED** 020

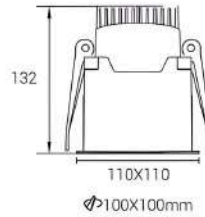

Model: DSE0420W
 Power: 20W
 Cutout : 125X125mm
 Size(WxLxH):135X135X132mm
 Beam Angle: 15°/24°/38°
 Standard holder: **CREE** 1507
 Optional holder: **ITILED** 020

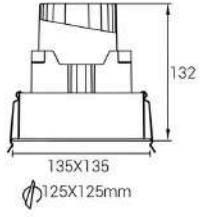

Direct
DSE0220W



Polarizer
PSE0220W



Acrylic
FSE0220W



Adjustable Direct
DSE0420W



Adjustable polarizer
PSE0420W

Power:20W



Model: DRE0220W/PRE0220W
 Power: 20W
 Cutout : Ø125mm
 Size(WxLxH): Ø107x132mm
 Beam Angle: 15°/24°/38°
 Standard holder: **CREE** 1507
 Optional holder: **ITILED** 020

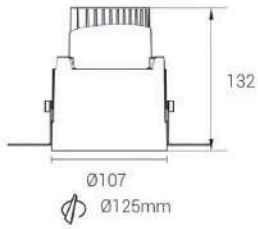

Direct
DRT0220W



Polarizer
PRT0220W



Acrylic
FRT0220W



Model: DRT0420W/PRT0420W
 Power: 20W
 Cutout : Ø125mm
 Size(WxLxH): Ø122x132mm
 Beam Angle: 15°/24°/38°
 Standard holder: **CREE** 1507
 Optional holder: **ITILED** 020

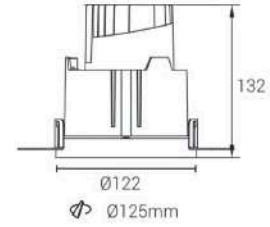

Adjustable Direct
DRT0420W



Adjustable polarizer
PRT0420W



Model: DSE0220W/PSE0220W
 Power:20W
 Cutout :100X100mm
 Size(WxLxH):98X98X132mm
 Beam Angle: 15°/24°/38°
 Standard holder: **CREE** 1507
 Optional holder: **ITILED** 020

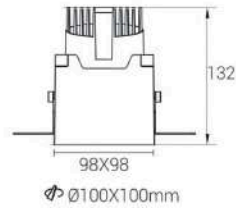

Direct
DST0220W



Polarizer
PST0220W



Acrylic
FST0220W



Model: DST0420W/PST0420W
 Power:20W
 Cutout : 125X125mm
 Size(WxLxH):122X122X132mm
 Beam Angle: 15°/24°/38°
 Standard holder: **CREE** 1507
 Optional holder: **ITILED** 020

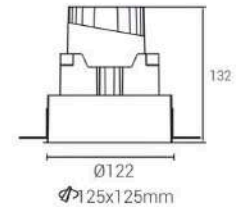

Adjustable Direct
DST0420W



Adjustable polarizer
PST0420W

TIANYUE series

Power:12W



Model: DST0206W-2

Power: 6WX2

Cutout :130X65mm

Size(WxLxH):139X71X83mm

Beam Angle: 15°/24°/38°

Standard holder: **CREE** 1304

Optional holder: **ITILED** 020

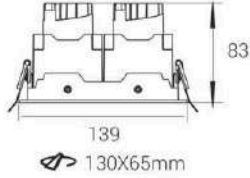

Direct
DSE0206W-2

Polarizer
PSE0206W-2

Power:24W



Model: DST0212W-2

Power:12WX2

Cutout : 175X85mm

Size(WxLxH):180X90X88mm

Beam Angle: 15°/24°/38°

Standard holder: **CREE** 1304

Optional holder: **ITILED** 020

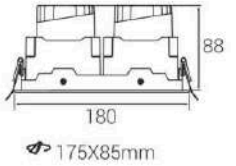

Direct
DSE0212W-2

Polarizer
PRE0212W-2



Model: DST0206W-2

Power: 6WX2

Cutout :130X70mm

Size(WxLxH): 125X65X83mm

Beam Angle: 15°/24°/38°

Standard holder: **CREE** 1304

Optional holder: **ITILED** 020

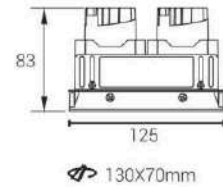

Direct
DST0206W-2

Polarizer
PST0206W-2



Model: DST0212W-2

Power: 12WX2

Cutout : 170X90mm

Size(WxLxH): 167X83X90mm

Beam Angle: 15°/24°/38°

Standard holder: **CREE** 1304

Optional holder: **ITILED** 020

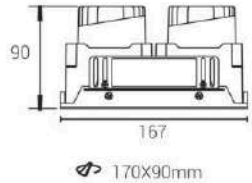

Direct
DST0212W-2

Polarizer
PST0212W-2

CREE **ITILED**



CREE **ITILED**



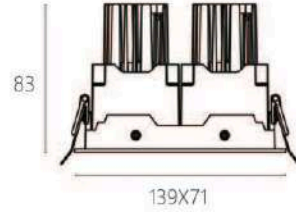

130x65mm

Model: DSE0210W-2-TJ
Power: 10WX2
Cutout : 130x65mm
Size(WxLxH):139x71x83mm
Standard holder: **CREE** 1304
Optional holder: **TILED** 020

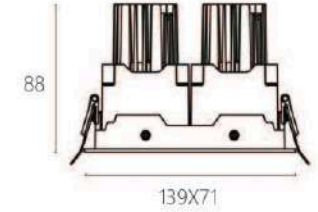
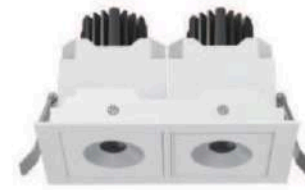

130x65mm

Model: DSE0210W-2-HD
Power: 10WX2
Cutout : 130x65mm
Size(WxLxH):139x71x88mm
Standard holder: **Shinlani** V4HD
Optional holder: **Shinlani** CXA13-HD

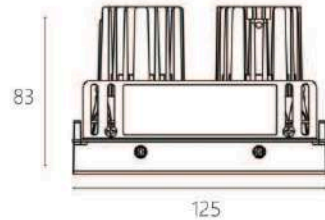

130x70mm

Model: DST0210W-2-TJ
Power: 10WX2
Cutout : 130x70mm
Size(WxLxH): 125X65X83mm
Standard holder: **CREE** 1304
Optional holder: **TILED** 020

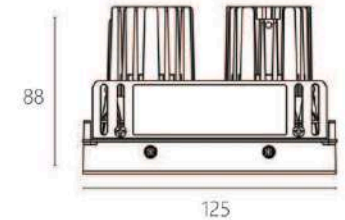

130x70mm

Model: DST0210W-2-HD
Power: 10WX2
Cutout : 130x70mm
Size(WxLxH): 125X65X88mm
Standard holder: **Shinlani** V4HD
Optional holder: **Shinlani** CXA13-HD

TIANYUE series

Power:10W/12W

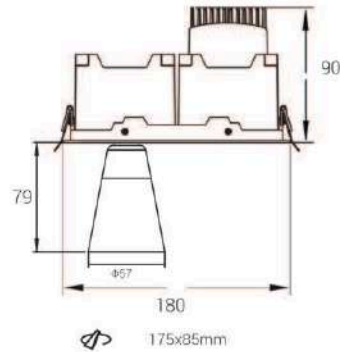

Model: SSE-0212W-LB/PST0212W
Power:10W/12W
Cutout : 175x85mm
Size(WxLxH):180x90x167mm
Standard holder: **CREE** 1304
Optional holder: **ITILED** 020



Model: DST0220W-2
Power:20WX2
Cutout : 214X105mm
Size(WxLxH):220X110X131mm
Standard holder: **CREE** 1507
Optional holder: **ITILED** 020

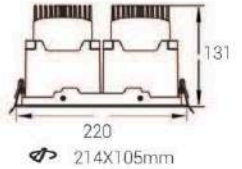

Power:40W



Direct
DSE0220W-2



Polarizer
PRE0220W-2

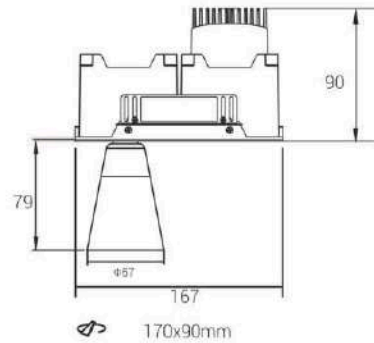

Model: SSE-0212W-LB/PST012W
Power: 10W/12W
Cutout : 170x90mm
Size(WxLxH): 167X83X169mm
Standard holder: **CREE** 1304
Optional holder: **ITILED** 020



Model: DST0220W-2
Power: 20WX2
Cutout : 210X110mm
Size(WxLxH): 220X110X132mm
Standard holder: **CREE** 1507
Optional holder: **ITILED** 020

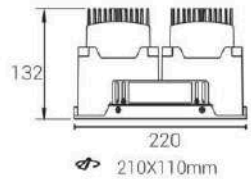

Direct
DST0220W-2



Polarizer
PST0220W-2

CREE **ITILED**



CREE **ITILED**





TIANYUE

Tianyue series is a variety of optical applications based on Linan series radiators, it integrates key lighting, facade lighting, indirect lighting, basic lighting, etc. Covering points, lines, surfaces and lighting optical applications can be based on different architectural styles. Freely switch different models to achieve ideal optical functions. The installation method can be embedded, frameless, surface mounted, hoisting, etc.



TIANYUE series

Power:6W



Model: MZ7001R-ZZ06W
 MZ7001R-PG06W
 MZ7001R-FG06W
 Power: 6W
 Size(WxLxH): Ø65X135mm
 Standard holder: **CREE** 1304
 Optional holder: **ITILED** 020

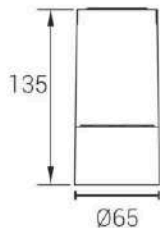

Direct



Polarizer



Acrylic

Model: DZ7001R-ZZ06W
 DZ7001R-PG06W
 DZ7001R-FG06W
 Power: 6W
 Size(WxLxH):Ø 65X135mm
 Standard holder: **CREE** 1304
 Optional holder: **ITILED** 020



Direct



Polarizer



Acrylic

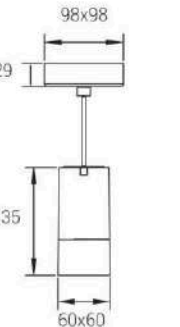
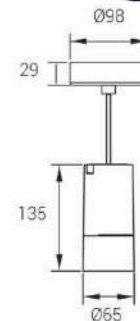

Model: MZ7001S-ZZ06W
 MZ7001S-PG06W
 MZ7001S-FG06W
 Power: 6W
 Size(WxLxH): 60X60X135mm
 Standard holder: **CREE** 1304
 Optional holder: **ITILED** 020

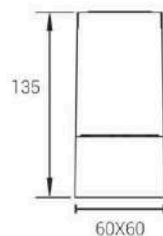

Direct



Polarizer



Acrylic



Direct



Polarizer



Acrylic

CREE ITILED



CREE ITILED



TIANYUE series

Power:10W

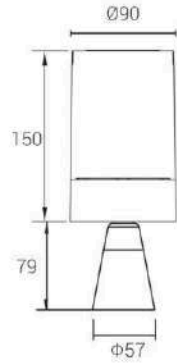

Model: MZ7001R-10W-DLBSD

Power: 10W

Size(WxLxH): Ø90X229mm

Standard holder: **CREE** 1507

Optional holder: **ITILED** 020

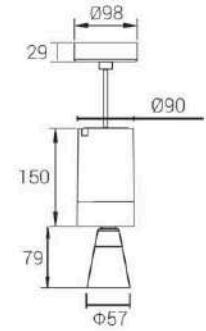

Model: DZ7001R-12W-DLBSD

Power: 10W

Size(WxLxH): Ø90X229mm

Standard holder: **CREE** 1507

Optional holder: **ITILED** 020

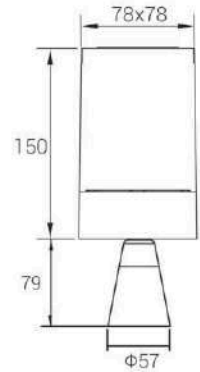

Model: MZ7001S-10W-DLBSD

Power: 10W

Size(WxLxH): 78X78X229mm

Standard holder: **CREE** 1507

Optional holder: **ITILED** 020

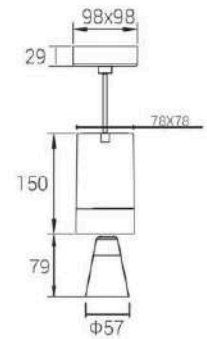

Model: DZ7001S-10W-DLBSD

Power: 10W

Size(WxLxH):78X78X229mm

Standard holder: **CREE** 1507

Optional holder: **ITILED** 020



TIANYUE series

Power:12W



Model: MZ7001R-ZZ12W
MZ7001R-PG12W
MZ7001R-FG12W
Power: 12W
Size(WxLxH): Ø90X150mm
Standard holder: **CREE** 1507
Optional holder: **ITILED** 020

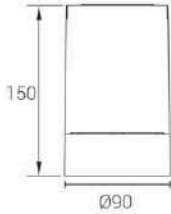

Model: DZ7001R-ZZ12W
DZ7001R-PG12W
DZ7001R-FG12W
Power: 12W
Size(WxLxH): Ø90X150mm
Standard holder: **CREE** 1507
Optional holder: **ITILED** 020

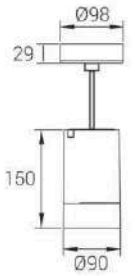

Direct



Polarizer



Acrylic



Direct



Polarizer



Acrylic



Model: MZ7001S-ZZ12W
MZ7001S-PG12W
MZ7001S-FG12W
Power: 12W
Size(WxLxH): 78X78X150mm
Standard holder: **CREE** 1507
Optional holder: **ITILED** 020

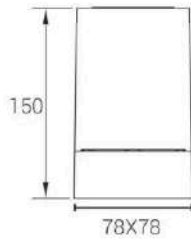

Model: DZ7001S-ZZ12W
DZ7001S-PG12W
DZ7001S-FG12W
Power: 12W
Size(WxLxH): 78X78X150mm
Standard holder: **CREE** 1507
Optional holder: **ITILED** 020

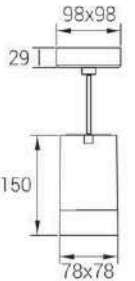

Direct



Polarizer



Acrylic



Direct



Polarizer



Acrylic



TIANYUE series

Power:12W

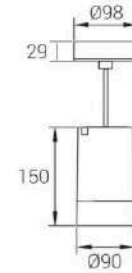
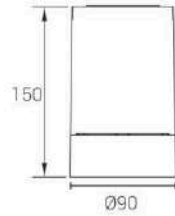

Model: MZ7001R-12W-HD

Power: 12W

Size(WxLxH): Ø90X150mm

Standard holder: **Shinlani** V4HD

Optional holder: **Shinlani** CXA13-HD

Model: DZ7001R-12W-HD

Power: 12W

Size(WxLxH): Ø90X150mm

Standard holder: **Shinlani** V4HD

Optional holder: **Shinlani** CXA13-HD

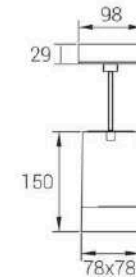
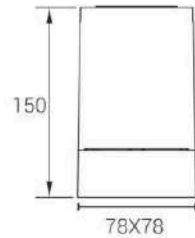

Model: MZ7001S-12W-HD

Power: 12W

Size(WxLxH): 78X78X150mm

Standard holder: **Shinlani** V4HD

Optional holder: **Shinlani** CXA13-HD

Model: DZ7001S-12W-HD

Power: 12W

Size(WxLxH): 78X78X150mm

Standard holder: **Shinlani** V4HD

Optional holder: **Shinlani** CXA13-HD

TIANYUE series

Power:12W

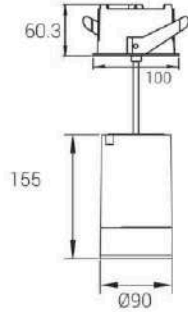

Model: DZ7002R-12W-FG-YB

Power: 12W

Cutout : Ø94mm

Size(WxLxH): Ø90X155mm

Standard holder: **CREE** 1507

Optional holder: **ITILED** 020

Ø94mm

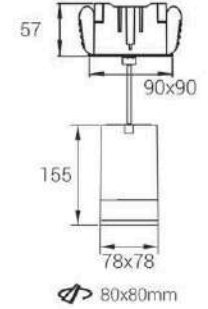

Model: DZ7002S-12W-FG-YB

Power: 12W

Cutout : 80x80mm

Size(WxLxH): 90x90X155mm

Standard holder: **CREE** 1507

Optional holder: **ITILED** 020

80x80mm

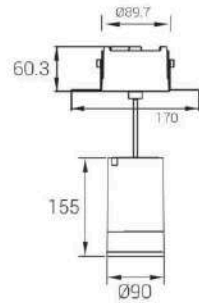

Model: DZ7002R-12W-FG-WB

Power: 12W

Cutout : 105mm

Size(WxLxH): Ø90X155mm

Standard holder: **CREE** 1507

Optional holder: **ITILED** 020

Ø105mm

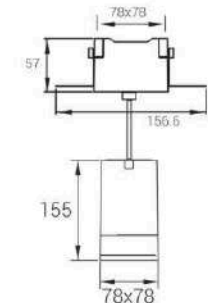

Model: DZ7002S-12W-FG-WB

Power: 12W

Cutout : 180x95mm

Size(WxLxH): 78x78X155mm

Standard holder: **CREE** 1507

Optional holder: **ITILED** 020

80x95mm

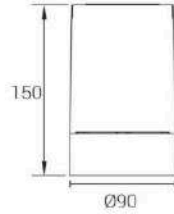

Model: MZ7001R-ZZ12W-TJ
Power: 18W
Size(WxLxH): Ø90X150mm
Standard holder: **CREE** 1507
Optional holder: **ITILED** 020

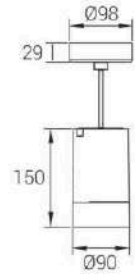

Model: DZ7001R-ZZ12W-TJ
Power: 18W
Size(WxLxH): Ø90X150mm
Standard holder: **CREE** 1507
Optional holder: **ITILED** 020

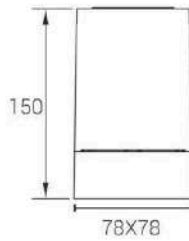

Model: MZ7001R-12W-TJ
Power: 18W
Size(WxLxH): 78X78X150mm
Standard holder: **CREE** 1507
Optional holder: **ITILED** 020

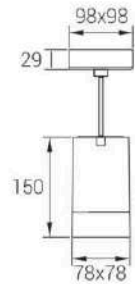

Model: DZ7001S-ZZ12W-TJ
Power: 18W
Size(WxLxH): 78X78X150mm
Standard holder: **CREE** 1507
Optional holder: **ITILED** 020

TIANYUE series

Power:20W



Model: MZ7001R-ZZ20W

MZ7001R-PG20W

Power: 20W

Size(WxLxH): Ø107X197mm

Standard holder: **CREE** 1507

Optional holder: **ITILED** 020

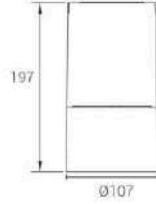

Direct



Polarizer



Model: DZ7001R-ZZ20W

DZ7001R-PG20W

Power: 20W

Size(WxLxH): Ø107X197mm

Standard holder: **CREE** 1507

Optional holder: **ITILED** 020

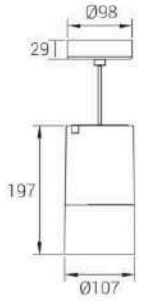

Direct



Polarizer



Model: MZ7001R-ZZ20W

MZ7001R-PG20W

Power: 20W

Size(WxLxH): 100X100X197mm

Standard holder: **CREE** 1507

Optional holder: **ITILED** 020

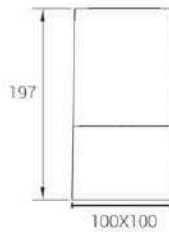

Direct



Polarizer



Model: DZ7001R-ZZ20W

DZ7001R-PG20W

Power: 20W

Size(WxLxH): 100X100X197mm

Standard holder: **CREE** 1507

Optional holder: **ITILED** 020

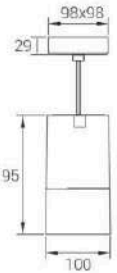

Direct



Polarizer

CREE **ITILED**



CREE **ITILED**



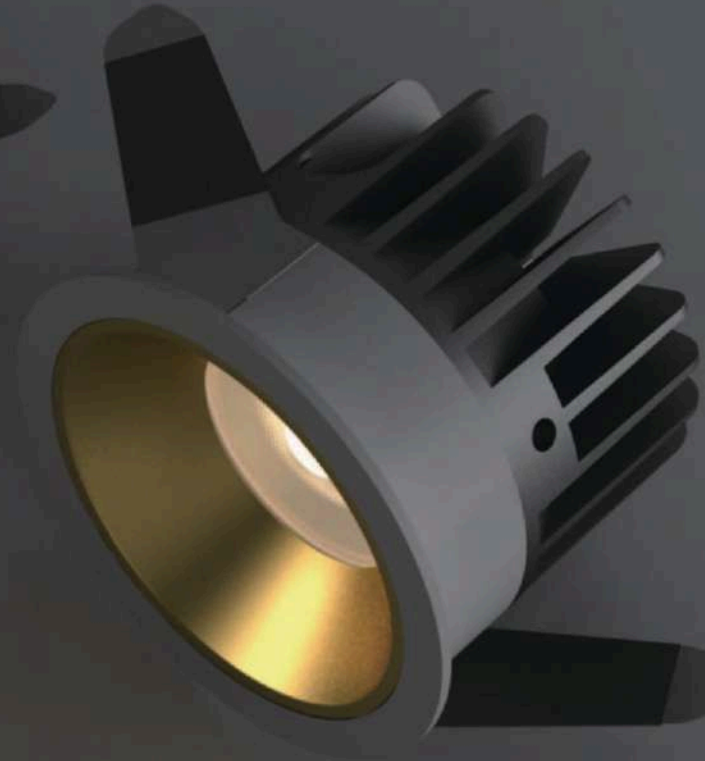



- Die-cast aluminium lamp body can effectively prevent corrosion and rust, make the lamp body fully heat dissipation, improve heat dissipation efficiency.
- It can be used as IP43 anti-fog and prevent fog and spray from contacting light source. It is suitable for kitchen and toilet.
- Two optical structures: fixed direct/adjustable oblique
- Equipped with an extremely narrow beam Angle, can be from different angles to accurately illuminate the subject.

Anti-glare spotlight

The unique ultra-thin shell design of this series makes it flexible to use in the limited space of the ceiling, thus reducing the construction difficulty. In addition, luminous surface no dark area, no point of light, uniform degree of highly consistent light effect, is Simple large space to provide basic lighting preferred products

1 The maximum lamp body of 16° can adjust the Angle, which greatly facilitates the lighting needs of on-site debugging.

2 Can be combined with honeycomb grid, effectively prevent excess astigmatism.

3 Reflectors of different colors can be selected according to the ceiling and the overall color of the space.

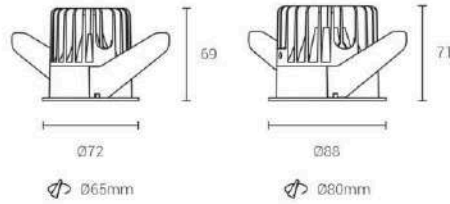

XQ1004

model: XQ1004	model: XQ1004
power: 10W	power: 15W
Cutout: Ø65mm	Cutout: Ø80mm
size(WxLxH): Ø72x69mm	size(WxLxH): Ø88x71mm
Beam angle: 15° / 24° / 36°	Beam angle: 15° / 24° / 36°
Standard holder: CREE 1507	Standard holder: CREE 1507
Optional holder: CREE 1304	Optional holder: CREE 1304

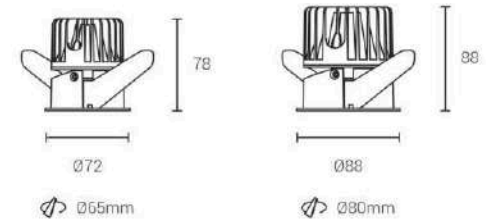
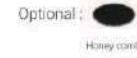

XQ1004

model: XQ1004A	model: XQ1004A
power: 10W	power: 15W
Cutout: Ø65mm	Cutout: Ø80mm
size(WxLxH): Ø72x78mm	size(WxLxH): Ø88x88mm
Beam angle: 15° / 24° / 36°	Beam angle: 15° / 24° / 36°
Standard holder: CREE 1507	Standard holder: CREE 1507
Optional holder: CREE 1304	Optional holder: CREE 1304

LED brand: **CREE**



LED brand: **CREE**





PRODUCT DATA

Model	GVB-R72S 06	GVB-R88M 12	GVB-R102L 18
Light source	SMD	SMD	SMD
Power	6W	12W	18W
Color temperature	2700k/3000k 3500k/4000k	2700k/3000k 3500k/4000k	2700k/3000k 3500k/4000k
Size(DxH)	φ72*51mm	φ88*57mm	φ102*57mm
Cutout	φ60mm	φ75mm	φ90mm



PRODUCT DATA

Model	GVB-S72S 06	GVB-S88M 12	GVB-S102L 18
Light source	SMD	SMD	SMD
Power	6W	12W	18W
Color temperature	2700k/3000k 3500k/4000k	2700k/3000k 3500k/4000k	2700k/3000k 3500k/4000k
Size(DxH)	72*72*51mm	88*88*57mm	102*102*57mm
Cutout	φ60mm	φ75mm	φ90mm

PRODUCT DATA

Model	GVB-L142S 12	GVB-L173M 24	GVB-L210L 36
Light source	SMD	SMD	SMD
Power	2*6W	2*12W	2*18W
Color temperature	2700k/3000k 3500k/4000k	2700k/3000k 3500k/4000k	2700k/3000k 3500k/4000k
Size(DxH)	142*72*51mm	173*88*57mm	210*102*57mm
Cutout	130*60mm	160*75mm	195*90mm

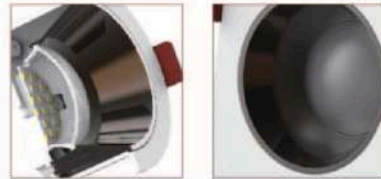

PRODUCT DATA

Model	GVB-L212S 18	GVB-L253M 36	GVB-L312L 54
Light source	SMD	SMD	SMD
Power	3*6W	3*12W	3*18W
Color temperature	2700k/3000k 3500k/4000k	2700k/3000k 3500k/4000k	2700k/3000k 3500k/4000k
Size(DxH)	212*72*51mm	253*88*57mm	312*102*57mm
Cutout	200*60mm	240*75mm	300*90mm



PRODUCT DATA

Model	GVB-S142S 24	GVB-S173M 48	GVB-S210L 72
Light source	SMD	SMD	SMD
Power	4*6W	4*12W	4*18W
Color temperature	2700k/3000k 3500k/4000k	2700k/3000k 3500k/4000k	2700k/3000k 3500k/4000k
Size(DxH)	142*142*51mm	173*173*57mm	210*210*57mm
Cutout	130*130mm	160*160mm	195*195mm

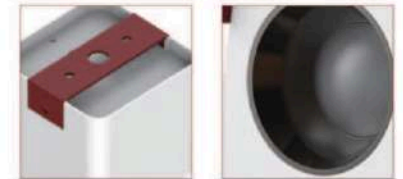
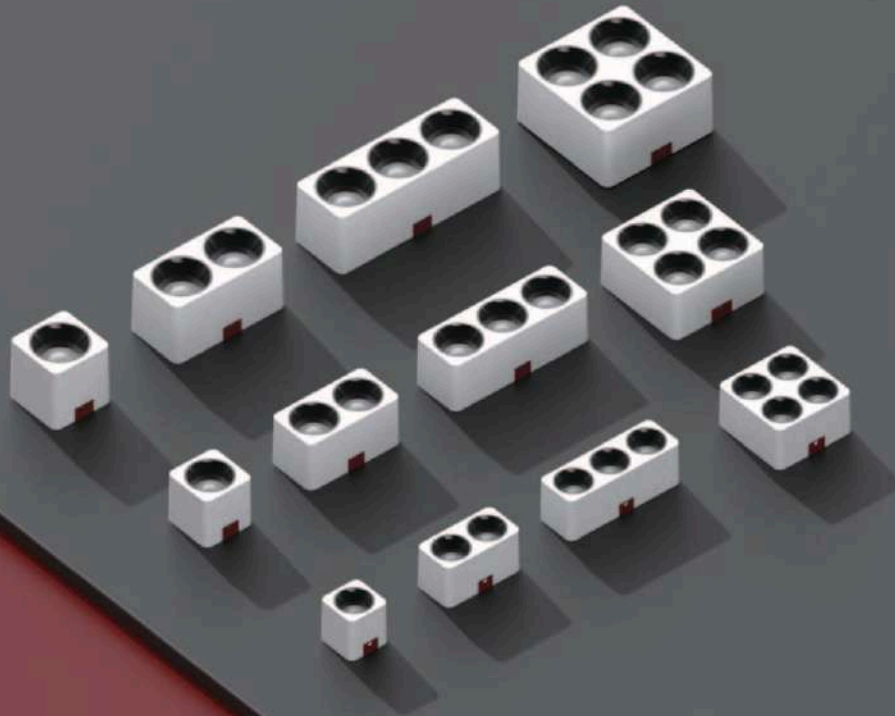

PRODUCT DATA

Model	GVB-SS67S 06	GVB-SS83M 12	GVB-SS98L 18
Light source	SMD	SMD	SMD
Power	6W	12W	18W
Color temperature	2700k/3000k 3500k/4000k	2700k/3000k 3500k/4000k	2700k/3000k 3500k/4000k
Size(DxH)	67*67*77mm	83*83*78mm	98*98*95mm

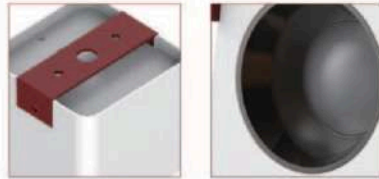

PRODUCT DATA

Model	GVB-SL130S 12	GVB-SL160M 24	GVB-SL190L 36
Light source	SMD	SMD	SMD
Power	2*6W	2*12W	2*18W
Color temperature	2700k/3000k 3500k/4000k	2700k/3000k 3500k/4000k	2700k/3000k 3500k/4000k
Size(DxH)	130*67*77mm	160*83*78mm	190*98*95mm

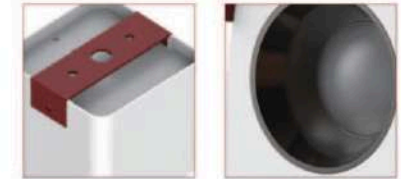

PRODUCT DATA

Model	GVB-SL195S 18	GVB-SL237M 36	GVB-SL282L 54
Light source	SMD	SMD	SMD
Power	3*6W	3*12W	3*18W
Color temperature	2700k/3000k 3500k/4000k	2700k/3000k 3500k/4000k	2700k/3000k 3500k/4000k
Size(DxH)	195*67*77mm	237*83*78mm	282*98*95mm

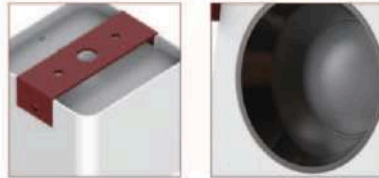

PRODUCT DATA

Model	GVB-SS130S 24	GVB-SS160M 48	GVB-SS190L 72
Light source	SMD	SMD	SMD
Power	4*6W	4*12W	4*18W
Color temperature	2700k/3000k 3500k/4000k	2700k/3000k 3500k/4000k	2700k/3000k 3500k/4000k
Size(DxH)	130*130*77mm	160*160*78mm	190*190*95mm

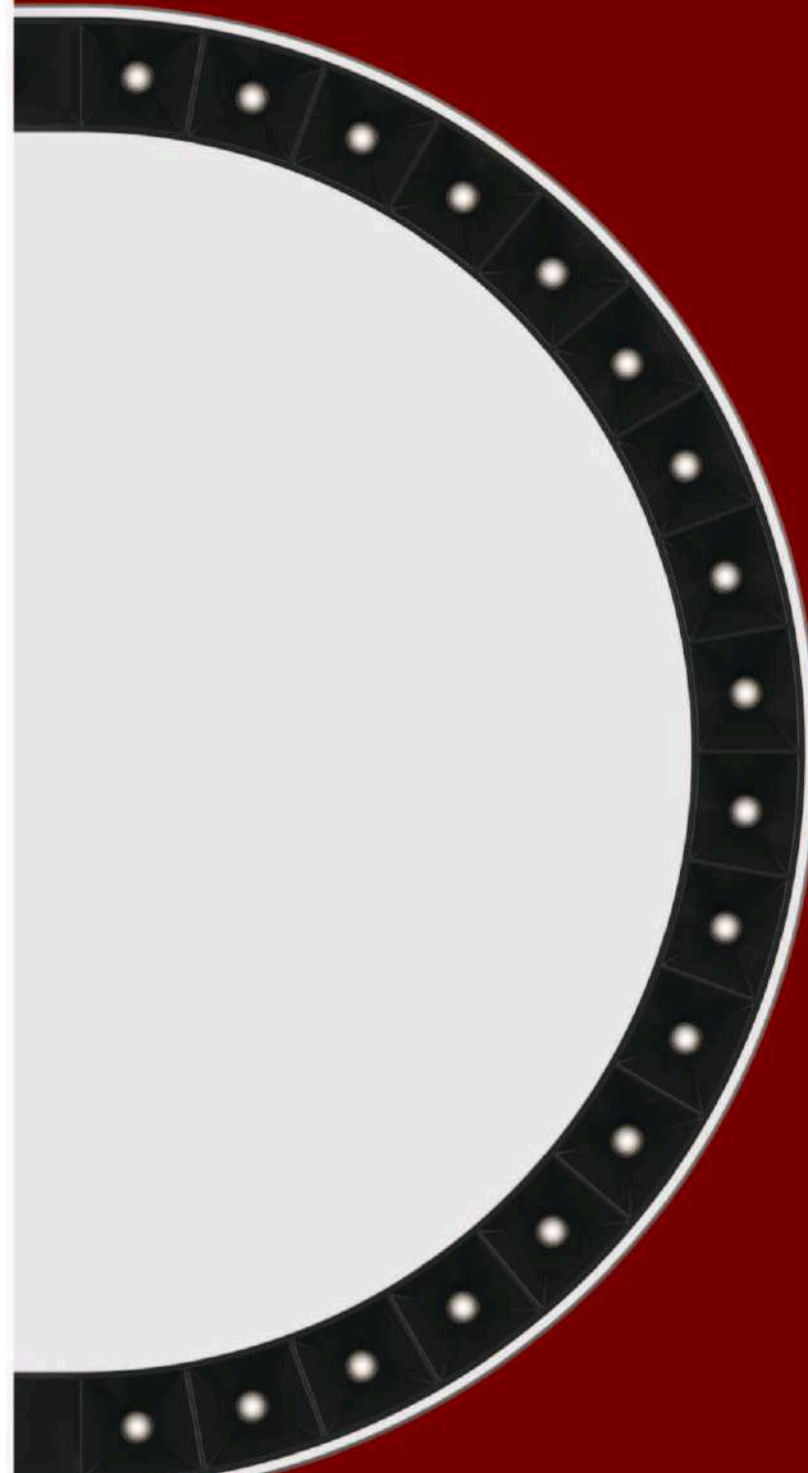

Pompeii



PRODUCT DATA

Model	GPP-R85 07	GPP-R100 12	GPP-R125 18
Light source	SMD-3030	SMD-3030	SMD-3030
Power	7W	12W	18W
Color temperature	2700k/3000k 3500k/4000k	2700k/3000k 3500k/4000k	2700k/3000k 3500k/4000k
Size(DxH)	φ85*35mm	φ100*35mm	φ125*35mm
Cutout	φ75mm	φ90mm	φ115mm

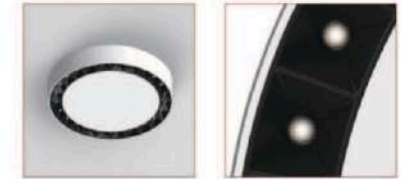
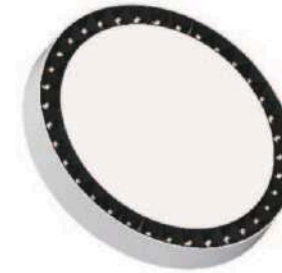

PRODUCT DATA

Model	GPP-SR255 24	GPP-SR355 36
Light source	SMD-3030	SMD-3030
Power	24W	36W
Color temperature	2700k/3000k 3500k/4000k	2700k/3000k 3500k/4000k
Size(DxH)	φ255*45mm	φ355*46mm



PRODUCT DATA

Model	GPP-R69X 07	GPP-R83X 12	GPP-R108X 18
Light source	SMD-3030	SMD-3030	SMD-3030
Power	7W	12W	18W
Color temperature	2700k/3000k 3500k/4000k	2700k/3000k 3500k/4000k	2700k/3000k 3500k/4000k
Size(DxH)	φ113*35mm	φ128*35mm	φ153*35mm
Cutout	φ75mm	φ90mm	φ115mm

Venice





PRODUCT DATA

Model	GV-MR85 07
Light source	SMD
Power	7W
Color temperature	2700k/3000k 3500k/4000k
Size(DxH)	φ85*38mm
Cutout	φ75mm



PRODUCT DATA

Model	GV-MS85 07
Light source	SMD
Power	7W
Color temperature	2700k/3000k 3500k/4000k
Size(DxH)	85*85*38mm
Cutout	φ75mm



PRODUCT DATA

Model	GV-ML168 14
Light source	SMD
Power	2*7W
Color temperature	2700k/3000k 3500k/4000k
Size(DxH)	168*85*38mm
Cutout	160*75mm



PRODUCT DATA

Model	GV-MR85X 07	GV-MR85X 12	GV-MR105X 18
Light source	COB	COB	COB
Power	7W	12W	18W
Color temperature	2700k/3000k 3500k/4000k	2700k/3000k 3500k/4000k	2700k/3000k 3500k/4000k
Size(DxH)	φ85*65mm	φ85*65mm	φ105*83mm
Cutout	φ75mm	φ75mm	φ95mm



PRODUCT DATA

Model	GV-MS85X 07	GV-MS85X 12	GV-MS105X 18
Light source	COB	COB	COB
Power	7W	12W	18W
Color temperature	2700k/3000k 3500k/4000k	2700k/3000k 3500k/4000k	2700k/3000k 3500k/4000k
Size(DxH)	85*85*65mm	85*85*65mm	105*105*83mm
Cutout	φ75mm	φ75mm	φ95mm

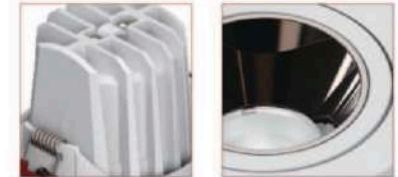

PRODUCT DATA

Model	GV-ML168X 14	GV-ML168X 24	GV-ML210X 36
Light source	COB	COB	COB
Power	2*7W	2*12W	2*18W
Color temperature	2700k/3000k 3500k/4000k	2700k/3000k 3500k/4000k	2700k/3000k 3500k/4000k
Size(DxH)	168*85*65mm	168*85*65mm	210*105*83mm
Cutout	160*75mm	160*75mm	200*95mm



PRODUCT DATA

Model	GX2-R55 05	GX2-R65 07	GX2-R75 12
Light source	COB	COB	COB
Power	5W	7W	12W
Color temperature	2700k/3000k 3500k/4000k	2700k/3000k 3500k/4000k	2700k/3000k 3500k/4000k
Size(DxH)	φ55*56mm	φ65*66mm	φ75*75.5mm
Cutout	φ45mm	φ55mm	φ65mm

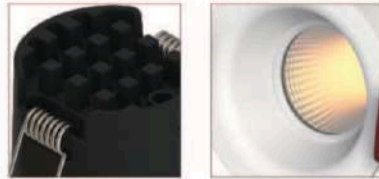

PRODUCT DATA

Model	GX2-S55 05	GX2-S65 07	GX2-S75 12
Light source	COB	COB	COB
Power	5W	7W	12W
Color temperature	2700k/3000k 3500k/4000k	2700k/3000k 3500k/4000k	2700k/3000k 3500k/4000k
Size(DxH)	55*55*58mm	65*65*66mm	75*75*75.5mm
Cutout	45*45mm	55*55mm	65*65mm

//





PRODUCT DATA

Model	GV2-R85M 07	GV2-R105L 12
Light source	COB	COB
Power	7W	12W
Color temperature	2700k/3000k 3500k/4000k	2700k/3000k 3500k/4000k
Size(DxH)	φ85*30mm	φ105*31mm
Cutout	φ75mm	φ95mm



PRODUCT DAT

Model	GV2-S85M 07	GV2-S105L 12
Light source	COB	COB
Power	7W	12W
Color temperature	2700k/3000k 3500k/4000k	2700k/3000k 3500k/4000k
Size(DxH)	85*85*30mm	105*105*31mm
Cutout	φ75mm	φ95mm



PRODUCT DATA

Model	GV2-L168M 14	GV2-L210L 24
Light source	COB	COB
Power	2*7W	2*12W
Color temperature	2700k/3000k 3500k/4000k	2700k/3000k 3500k/4000k
Size(DxH)	168*85*30mm	210*105*31mm
Cutout	180*75mm	200*95mm



PRODUCT DATA

Model	GV2-MR85M 07	GV2-MR105L 12
Light source	COB	COB
Power	7W	12W
Color temperature	2700k/3000k 3500k/4000k	2700k/3000k 3500k/4000k
Size(DxH)	φ85*33mm	φ105*38mm
Cutout	φ75mm	φ95mm



PRODUCT DATA

Model	GV2-MS85M 07	GV2-MS105L 12
Light source	COB	COB
Power	7W	12W
Color temperature	2700k/3000k 3500k/4000k	2700k/3000k 3500k/4000k
Size(DxH)	85*85*33mm	105*105*38mm
Cutout	φ75mm	φ95mm



PRODUCT DATA

Model	GV2-ML168M 14	GV2-ML210L 24
Light source	COB	COB
Power	2*7W	2*12W
Color temperature	2700k/3000k 3500k/4000k	2700k/3000k 3500k/4000k
Size(DxH)	168*85*33mm	210*105*38mm
Cutout	160*75mm	200*95mm



PRODUCT DATA

Model	GV2-SR75M 07	GV2-SR90L 12
Light source	COB	COB
Power	7W	12W
Color temperature	2700k/3000k 3500k/4000k	2700k/3000k 3500k/4000k
Size(DxH)	φ75*55mm	φ90*60mm



PRODUCT DATA

Model	GV2-SS75M 07	GV2-SS90L 12
Light source	COB	COB
Power	7W	12W
Color temperature	2700k/3000k 3500k/4000k	2700k/3000k 3500k/4000k
Size(DxH)	75*75*55mm	90*90*60mm



HS20 Series MAGNETIC GRILLE LIGHT

6W/12W/18W/24W/30W/45W



6 Heads Lamp

WHITE BLACK

Dimensions

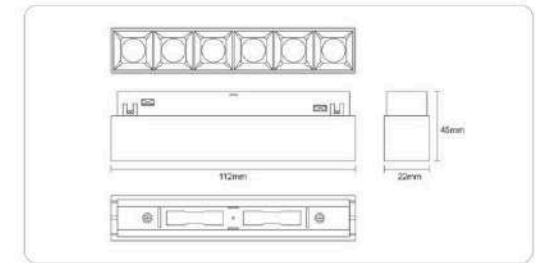

PRODUCT PARAMETERS

Model NO.	Input	System Power	LED Power	CRI	Beam Angle	CCT
HS26-6T	48V	6W	OSRAM	Ra>90	36°	3000K,4000K,More..



12 Heads Lamp

WHITE BLACK

Dimensions /

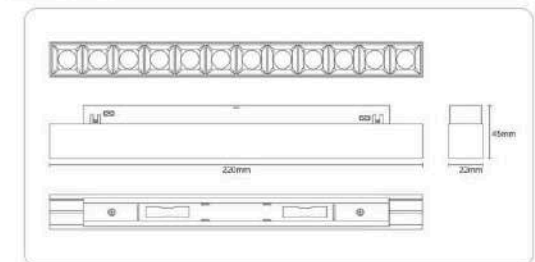

PRODUCT PARAMETERS

Model NO.	Input	System Power	LED Power	CRI	Beam Angle	CCT
HS26-12T	48V	12W	OSRAM	Ra>90	36°	3000K,4000K,More..



18 Heads Lamp

WHITE BLACK

Dimensions

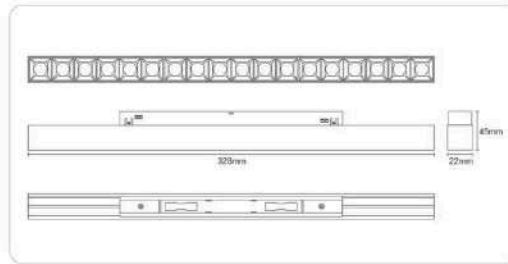

PRODUCT PARAMETERS

Model NO.	Input	System Power	LED Power	CRI	Beam Angle	CCT
HS26-18T	48V	18W	OSRAM	Ra>90	36°	3000K,4000K,More..



30 Heads Lamp

WHITE BLACK

Dimensions

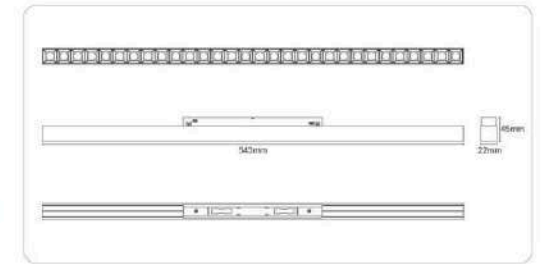

PRODUCT PARAMETERS

Model NO.	Input	System Power	LED Power	CRI	Beam Angle	CCT
HS26-30T	48V	30W	OSRAM	Ra>90	36°	3000K,4000K,More..



24 Heads Lamp

WHITE BLACK

Dimensions

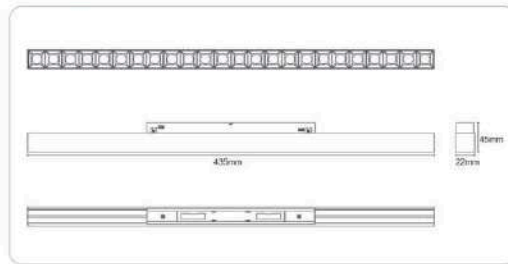

PRODUCT PARAMETERS

Model NO.	Input	System Power	LED Power	CRI	Beam Angle	CCT
HS26-24T	48V	24W	OSRAM	Ra>90	36°	3000K,4000K,More..



60Heads Lamp

WHITE BLACK

Dimensions

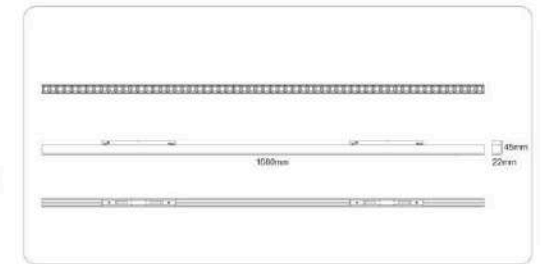

PRODUCT PARAMETERS

Model NO.	Input	System Power	LED Power	CRI	Beam Angle	CCT
HS26-60T	48V	45W	OSRAM	Ra>90	36°	3000K,4000K,More..

MAGNETIC FLOOD LIGHT

10W/20W/30W

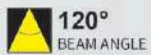

300 Flood Light

WHITE BLACK

Dimensions

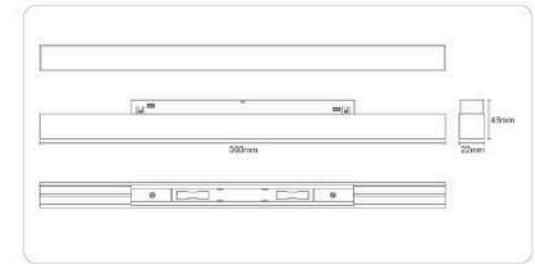

PRODUCT PARAMETERS

Model NO.	Input	System Power	LED Power	CRI	Beam Angle	CCT
HS26-300F	48V	10W	OSRAM	Ra>90	120°	3000K,4000K,More..



600 Flood Light

WHITE BLACK

Dimensions

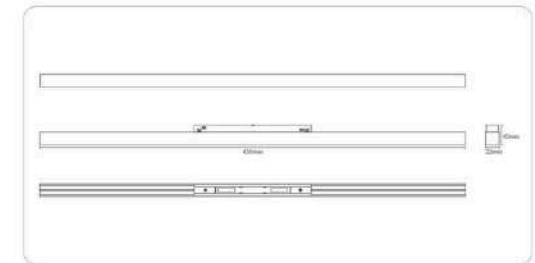

PRODUCT PARAMETERS

Model NO.	Input	System Power	LED Power	CRI	Beam Angle	CCT
HS26-600F	48V	20W	OSRAM	Ra>90	120°	3000K,4000K,More..



900 Flood Light

WHITE BLACK

Dimensions

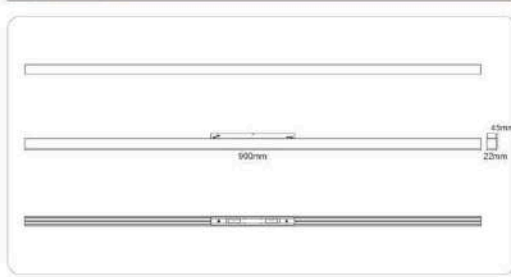

PRODUCT PARAMETERS

Model NO.	Input	System Power	LED Power	CRI	Beam Angle	CCT
HS26-900F	48V	30W	OSRAM	Ra>90	120°	3000K,4000K,More...



1200 Flood Light

WHITE BLACK

Dimensions

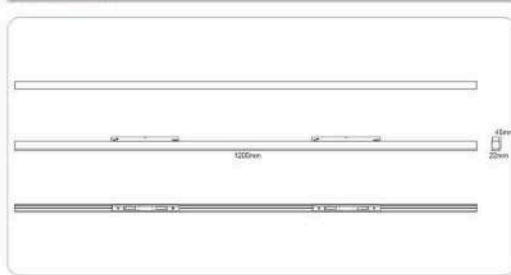

PRODUCT PARAMETERS

Model NO.	Input	System Power	LED Power	CRI	Beam Angle	CCT
HS26-1200F	48V	40W	OSRAM	Ra>90	120°	3000K,4000K,More...

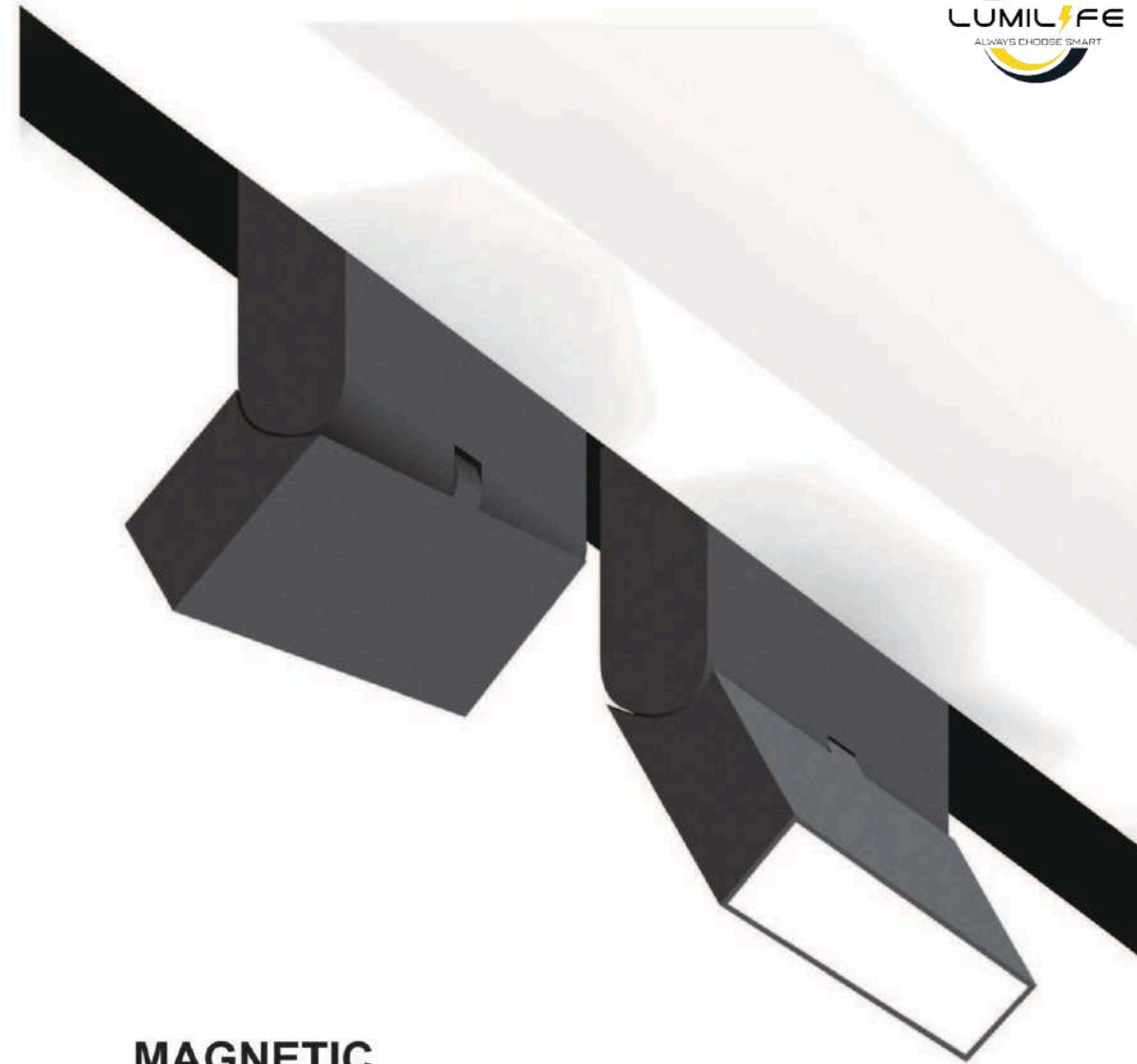

MAGNETIC FOLDING LIGHT

6W/12W/24W





6Heads grill light

WHITE BLACK

Dimensions

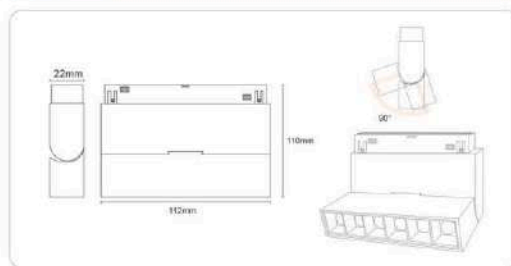

PRODUCT PARAMETERS

Model NO.	Input	System Power	LED Power	CRI	Beam Angle	CCT
HS-CX003-6T	48V	6W	OSRAM	Ra>90	36°	3000K,4000K,More..



6 Fold Flood Light

WHITE BLACK

Dimensions

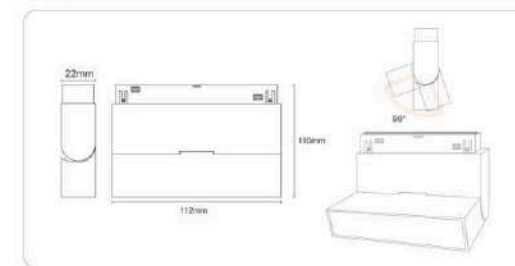

PRODUCT PARAMETERS

Model NO.	Input	System Power	LED Power	CRI	Beam Angle	CCT
HS-CX003-6F	48V	6W	OSRAM	Ra>90	120°	3000K,4000K,More..



12Heads grill light

WHITE BLACK

Dimensions

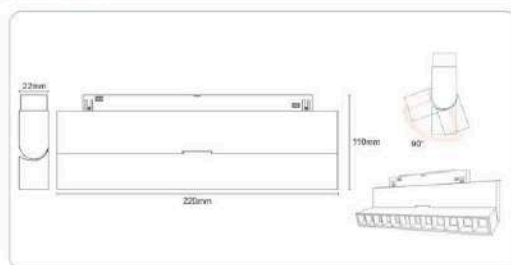

PRODUCT PARAMETERS

Model NO.	Input	System Power	LED Power	CRI	Beam Angle	CCT
HS-CX003-12T	48V	12W	OSRAM	Ra>90	36°	3000K,4000K,More..



12 Fold Flood Light

WHITE BLACK

Dimensions

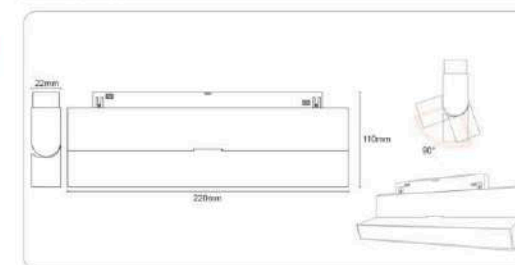

PRODUCT PARAMETERS

Model NO.	Input	System Power	LED Power	CRI	Beam Angle	CCT
HS-CX003-12F	48V	12W	OSRAM	Ra>90	120°	3000K,4000K,More..



5 Heads fold grill

WHITE BLACK

Dimensions

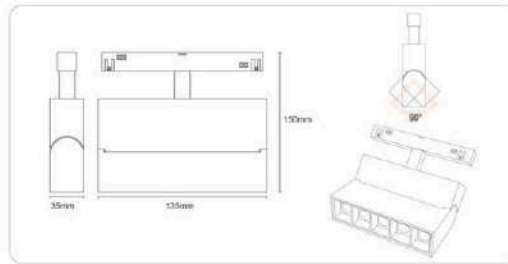

PRODUCT PARAMETERS

Model NO.	Input	System Power	LED Power	CRI	Beam Angle	CCT
HS-CX003-5T	48V	12W	OSRAM	Ra>90	36°	3000K,4000K,More..



10 Heads fold grill

WHITE BLACK

Dimensions / 尺寸

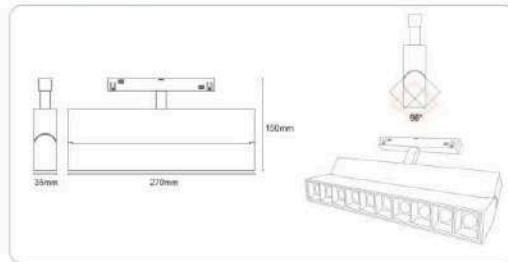

PRODUCT PARAMETERS

Model NO.	Input	System Power	LED Power	CRI	Beam Angle	CCT
HS-CX003-10T	48V	24W	OSRAM	Ra>90	36°	3000K,4000K,More..



MAGNETIC SPOT LIGHT

7W/12W/24W





35 Track light

 WHITE BLACK

PRODUCT PARAMETERS

Model NO.	Input	System Power	LED Power	CRI	Beam Angle	CCT
HS-CX035	48V	7W	普瑞	Ra>90	24°	3000K,4000K,More..

Dimensions

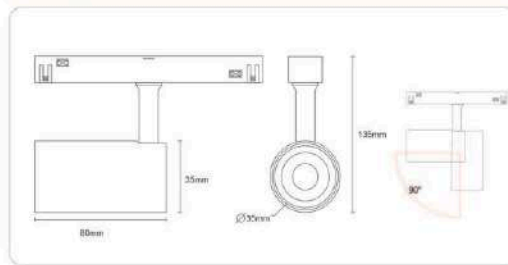

45 Track Light

 WHITE BLACK

PRODUCT PARAMETERS

Model NO.	Input	System Power	LED Power	CRI	Beam Angle	CCT
HS-CX045	48V	12W	普瑞	Ra>90	24°	3000K,4000K,More..

Dimensions

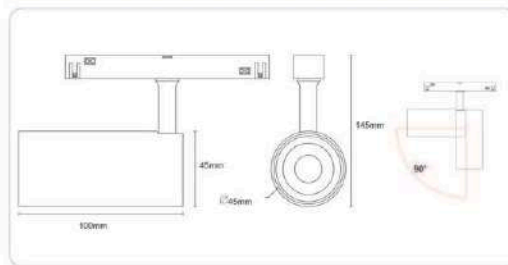

40 Track Light

 WHITE BLACK

Dimensions

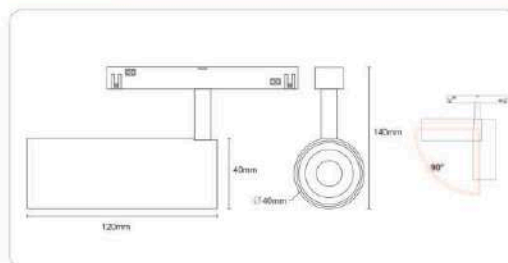

Model NO.	Input	System Power	LED Power	CRI	Beam Angle	CCT
HS-CX040	48V	7W	CREE	Ra>90	24°	3000K,4000K,More..



60 Track Light

 WHITE BLACK

PRODUCT PARAMETERS

Model NO.	Input	System Power	LED Power	CRI	Beam Angle	CCT
HS-CX060	48V	12W	CREE	Ra>90	24°	3000K,4000K,More..

Dimensions

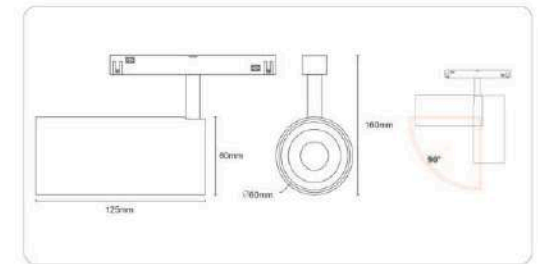

70 Track Light

 WHITE BLACK

PRODUCT PARAMETERS

Model NO.	Input	System Power	LED Power	CRI	Beam Angle	CCT
HS-CX070	48V	24W	CREE	Ra>90	24°	3000K,4000K,More..

Dimensions

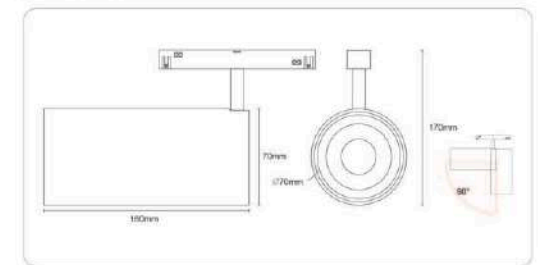



90 Flood Light

☐ WHITE ■ BLACK

Dimensions

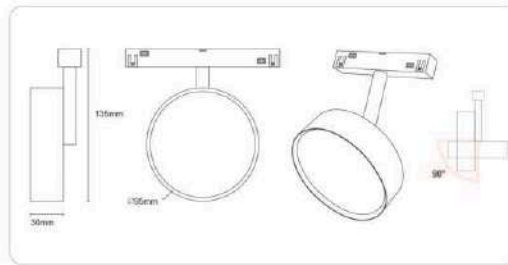

PRODUCT PARAMETERS

Model NO.	Input	System Power	LED Power	CRI	Beam Angle	CCT
HS-CXB90	48V	9W	普通	Ra>90	120°	3000K,4000K,More..



9 Heads grill light

☐ WHITE ■ BLACK

Dimensions

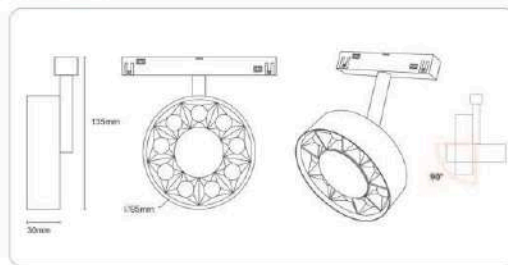

PRODUCT PARAMETERS

Model NO.	Input	System Power	LED Power	CRI	Beam Angle	CCT
HS-CXG90	48V	9W	普通	Ra>90	24°	3000K,4000K,More..



MAGNETIC
SUSPENSION LIGHT

12W





Pendant

WHITE BLACK

Dimensions

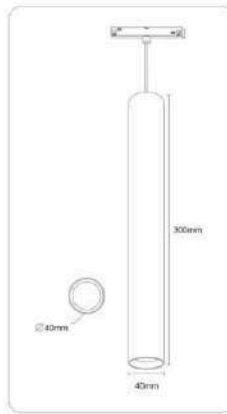

PRODUCT PARAMETERS

Model NO.	HS-CXD300
Input	48V
System Power	12W
LED Power	CREE
CRI	Ra>90
Beam Angle	24°
CCT	3000K,4000K,More..
Luminous Flux	600-800 lms

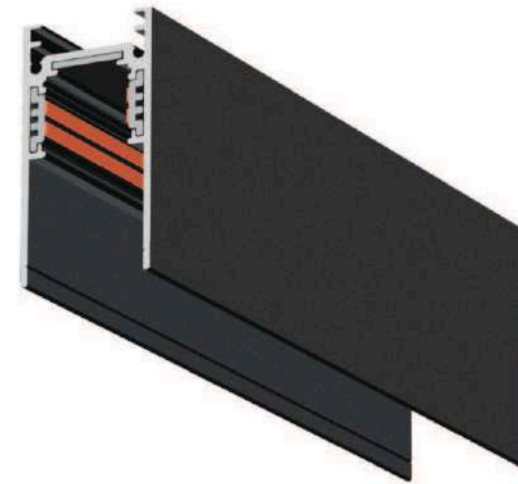

Surface BLACK

Mounting way: Surface Mount

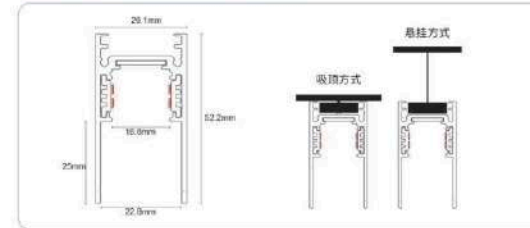

PRODUCT PARAMETERS

Model NO.	HS-26C
Track Length	100cm, 150cm, 200cm, 300cm
Package	9/Cartron/箱



Pendant

WHITE BLACK

Dimensions

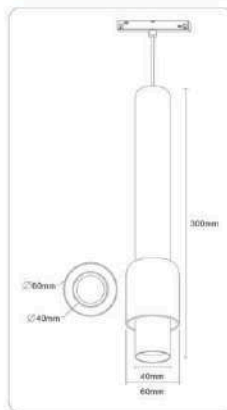

PRODUCT PARAMETERS

Model NO.	HS-CXD5L300
Input	48V
System Power	12W
LED Power	CREE
CRI	Ra>90
Beam Angle	24°
CCT	3000K,4000K,More..
Luminous Flux	600-800 lms



90° Horizontal angle

It is used for the ceiling track rail connection only



90° Vertical angle

It's used for the ceiling to wall track rail mount

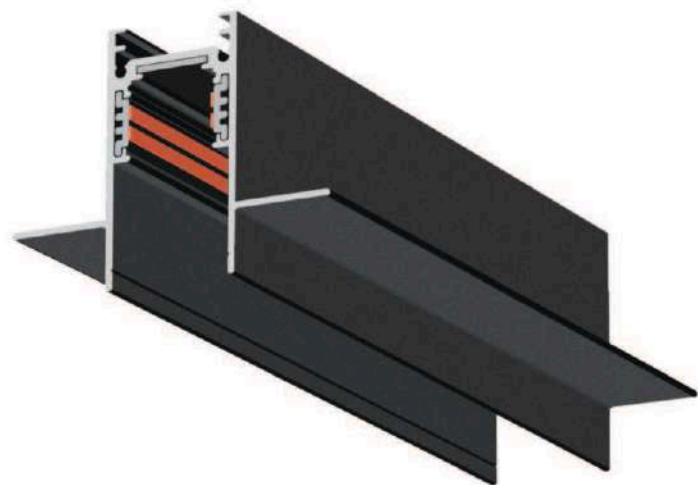

Recessed ■ BLACK

Mounting way: Recessed mount

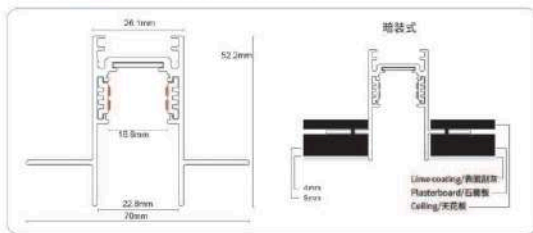

PRODUCT PARAMETERS

Model NO.	HS-26D
Track Length	100cm, 150cm, 200cm, 300cm
Package	5/Cartron/箱

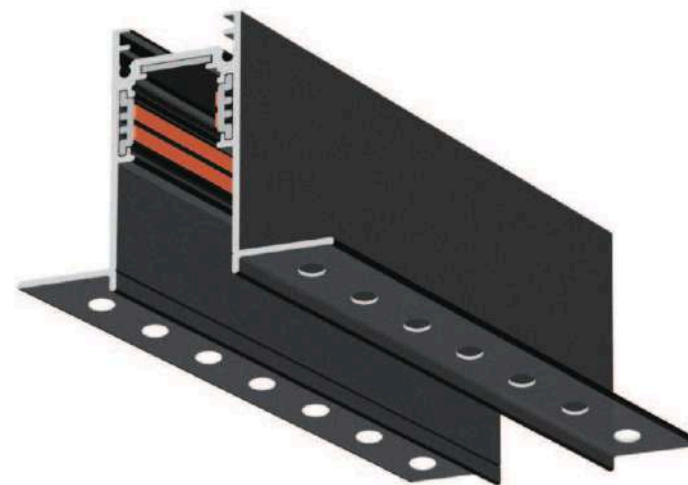

Trimless ■ BLACK

Mounting Way: Trimless recessed mount

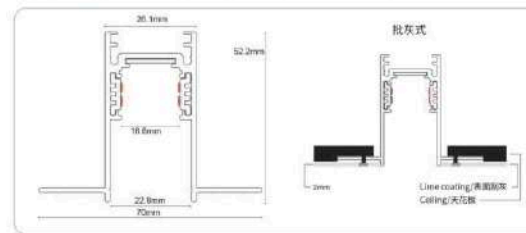

PRODUCT PARAMETERS

Model NO.	HS-26E
Track Length	100cm, 150cm, 200cm, 300cm
Package	5/Cartron/箱



90° Horizontal angle

It is used for the ceiling track rail connection only



90° Vertical angle

It's used for the ceiling to wall track rail mount



90° Horizontal angle

It is used for the ceiling track rail connection only



90° Vertical angle

It's used for the ceiling to wall track rail mount



I connector

It is used to connect two track rail together



Input connector

It is used to connect the track rail and the 48V power supply or DALI



Outer 100W

Meanwell Driver Power Supply



Outer 200W

Meanwell Driver Power Supply

Outer Put 48V power supplier transfer

Input voltage: 85-220V

Out put voltage: 48V

It is used to transfer 220V voltage to 48V

Notification

In one track rail, if total lamp watt is 100W, then choose 150W driver, increase driver power at least 30-50% than lamps' power



Soft Connector A

It is used for two track rails(shorter wire)



Soft Connector B

It is used to connect two track rails together, will be used with 90° angle.



Inner driver 100W

48V Power Supplier



Inner driver 200W

48V Power Supplier

嵌入轨道式变压器

Input voltage: 85-220V

Output Voltage:48V

It is used to transfer 220V voltage to 48V

Notification

In one track rail, if total lamp watt is 100W, then choose 150W driver, increase driver power at least 30-50% than lamps' power



Rail Connection

It is used on the back side of surface mount track rail



Hanging kits

It is used for pendant mounting track rails



Remote Control

It should be used with dimmable lamps



Control Board

It should be used with dimmable lamps



MT26 SERIES



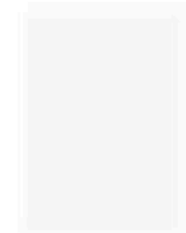

Product Code: MT26-Y80
Watt: 8W
>CRI: Ra90
Voltage: 48V
Product Size: 75x75mm
Color: Black / White
Material: aluminum + plastic

CCT

3000K/4000K/5700K

Beam angle



24°

System Options



ON-OFF



2.4GHz



mijia



ZigBee

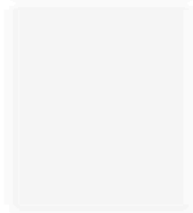

Product Code: MT26-YT80
Watt: 5W
>CRI: Ra90
Voltage: 48V
Product Size: 75x75mm
Color: Black / White
Material: aluminum + plastic

CCT
3000K/4000K/5700K

Beam angle
24°

System Options
ON-OFF 2.4GHz mijia ZigBee



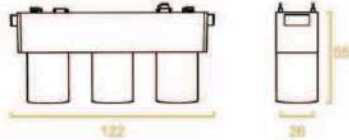
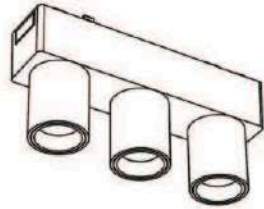
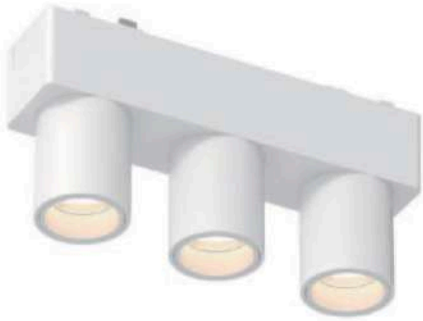

Product Code: MT26-3TY
 Watt: 5W
 >CRI: Ra90
 Voltage: 48V
 Product Size: 122x26x55mm
 Color: Black / White
 Material: aluminum + plastic

CCT

3000K/4000K/5700K

Beam angle



24°

System Options



ON-OFF



2.4GHz



mijia



ZigBee



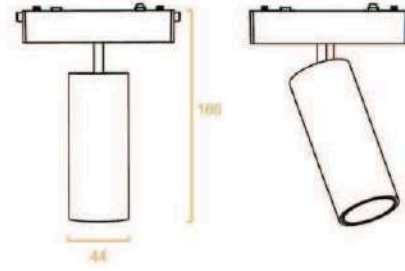

Product Code: MT26-T44
 Watt: 9W
 >CRI: Ra90
 Voltage: 48V
 Product Size: 44x110mm
 Color: Black / White
 Material: aluminum + plastic

CCT
 3000K/4000K/5700K

Beam angle
 24°

System Options





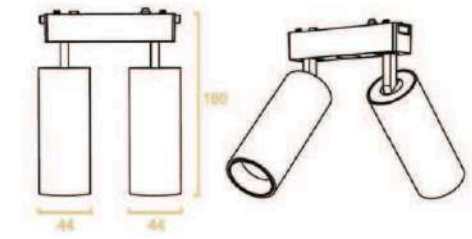

Product Code: MT26-T44-2
 Watt: 9Wx2
 >CRI: Ra90
 Voltage: 48V
 Product Size: 44x110mm
 Color: Black / White
 Material: aluminum + plastic

CCT
 3000K/4000K/5700K

Beam angle
 24°

System Options





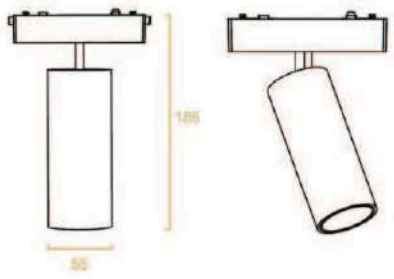

Product Code: MT26-T55
 Watt: 18W
 >CRI: Ra90
 Voltage: 48V
 Product Size: 55x135mm
 Color: Black / White
 Material: aluminum + plastic

CCT
 3000K/4000K/5700K

Beam angle
 24°

System Options
 ON-OFF 2.4GHz mijia ZigBee

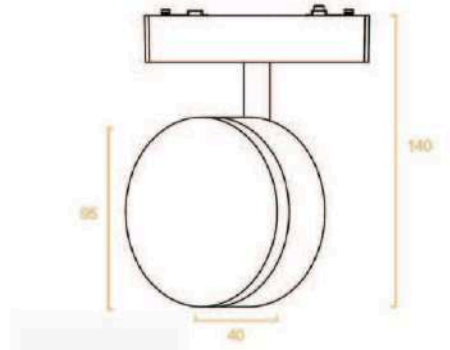

Product Code: MT26-Z90
 Watt: 9W
 >CRI: Ra90
 Voltage: 48V
 Product Size: 95x40mm
 Color: Black / White
 Material: aluminum + plastic

CCT
 3000K/4000K/5700K

Beam angle
 180°

System Options
 ON-OFF 2.4GHz mijia ZigBee

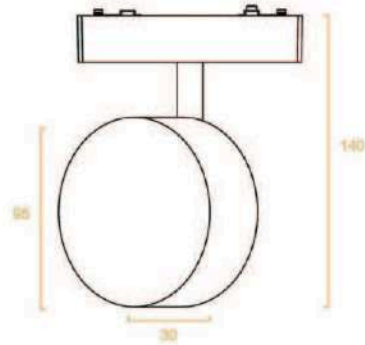

Product Code: MT26-B90
 Watt: 9W
 >CRI: Ra90
 Voltage: 48V
 Product Size: 95x30mm
 Color: Black / White
 Material: aluminum + plastic

CCT

3000K/4000K/5700K

Beam angle



150°

System Options

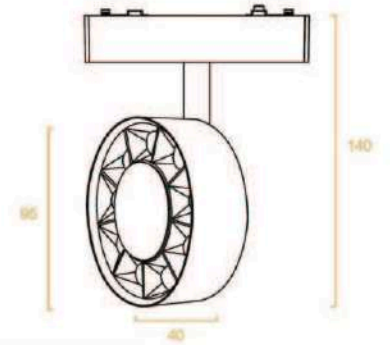

Product Code: MT26-G90
 Watt: 9W
 >CRI: Ra90
 Voltage: 48V
 Product Size: 95x30mm
 Color: Black / White
 Material: aluminum + plastic

CCT

3000K/4000K/5700K

Beam angle



24°

System Options



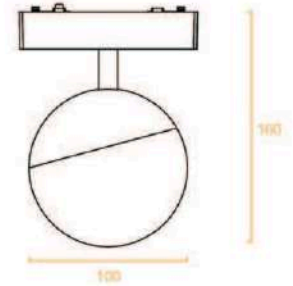

Product Code: MT26-100F
Watt: 5W
>CRI: Ra90
Voltage: 48V
Product Size: 100x100mm
Color: Black / White
Material: aluminum + plastic

CCT

3000K/4000K/5700K

Beam angle



180°

System Options



ON-OFF



2.4GHz



mija



ZigBee

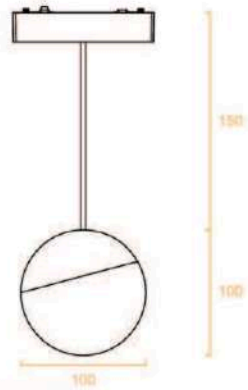

Product Code: MT26-D100F
 Watt: 5W
 >CRI: Ra90
 Voltage: 48V
 Product Size: 100x100mm
 Color: Black / White
 Material: aluminum + plastic

CCT
 3000K 4000K 5700K

Beam angle
 180°

System Options
 ON-OFF 2.4GHz mija ZigBee



Product Code: MT26-D300
 Watt: 6W
 >CRI: Ra90
 Voltage: 48V
 Product Size: 30x300mm
 Color: Black / White
 Material: aluminum + plastic

CCT
 3000K 4000K 5700K

Beam angle
 24°

System Options
 ON-OFF 2.4GHz mija ZigBee

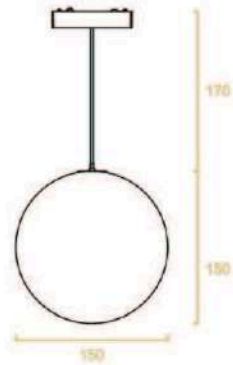

Product Code: MT26-Y150
MT26-D150
Watt: 5W
>CRI: Ra90
Voltage: 48V
Product Size: 150x150mm
Color: Black / White
Material: aluminum + plastic



CCT

- 3000K/4000K/5700K

Beam angle

- 360°

System Options

- ON-OFF
- 2.4GHz
- mija
- ZigBee

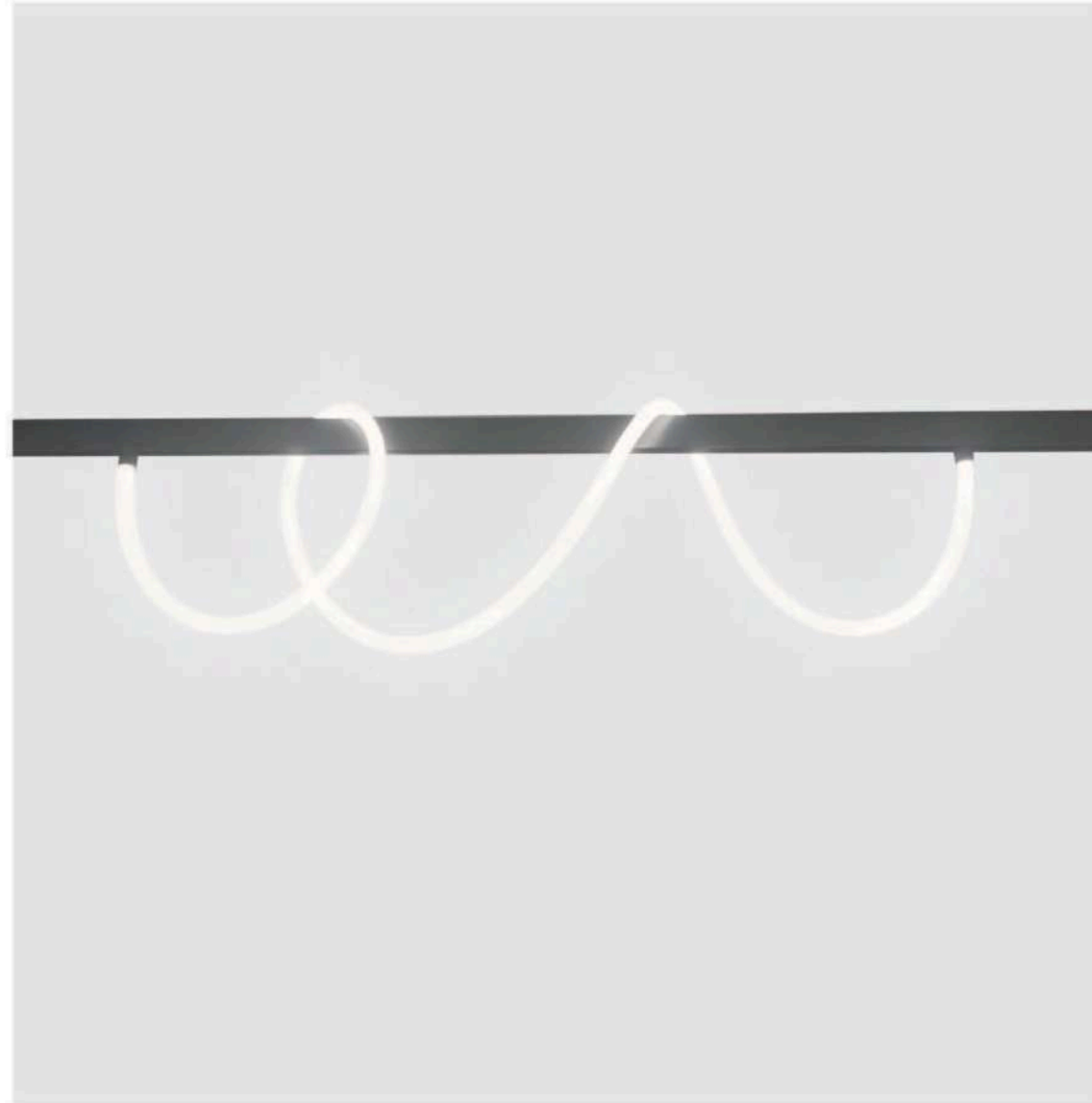

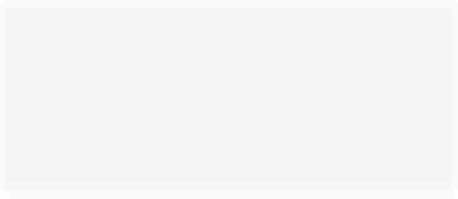

Soft/Adjustable

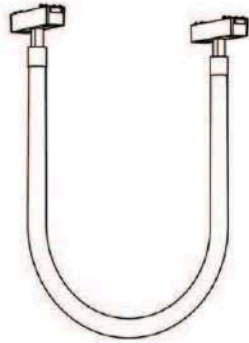

Specifications: 500mm 1000mm 1500mm
2000mm 3000mm 4000mm



Product Code: MT26-GJ
Watt: 8W - 80W
>CRI: Ra90
Voltage: 48V
Product Size: 500mm - 4000mm
Color: Black / White
Material: aluminum + plastic

CCT

3000K/4000K/5700K

Beam angle



360°

System Options



ON-OFF



2.4GHz



mijia



ZigBee

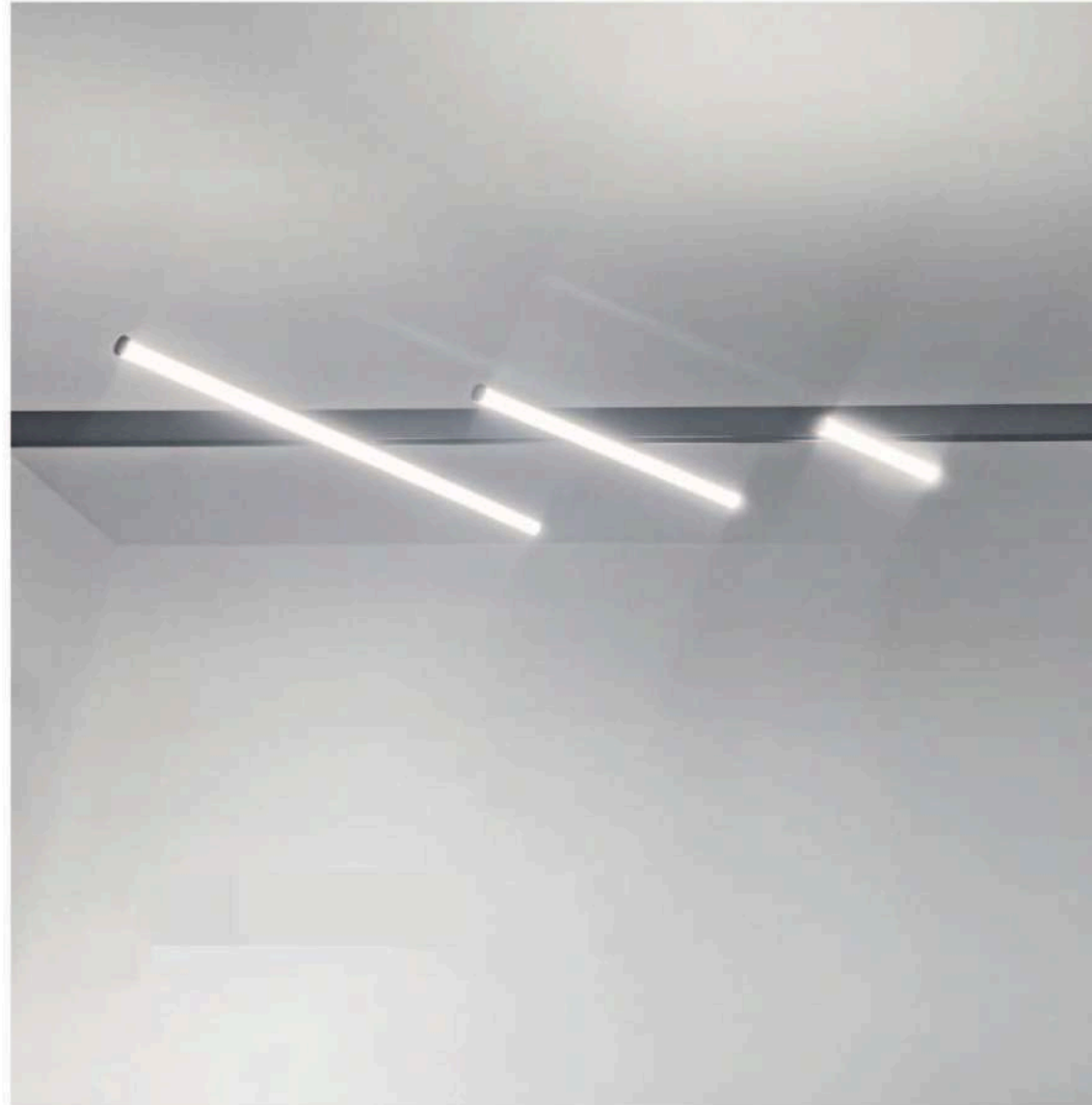

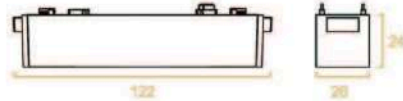
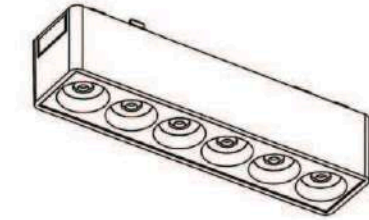

Product Code: MT26-6T
 Watt: 6W
 >CRI: Ra90
 Voltage: 48V
 Product Size: 122x26x24mm
 Color: Black / White
 Material: aluminum + plastic

CCT

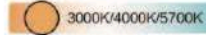

Beam angle



System Options

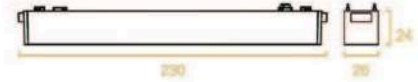
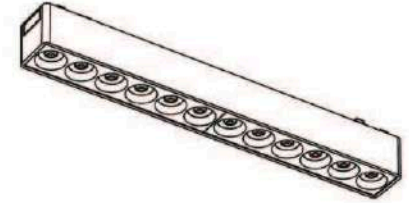

Product Code: MT26-12T
 Watt: 12W
 >CRI: Ra90
 Voltage: 48V
 Product Size: 230x26x24mm
 Color: Black / White
 Material: aluminum + plastic

CCT

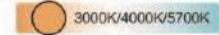

Beam angle



System Options



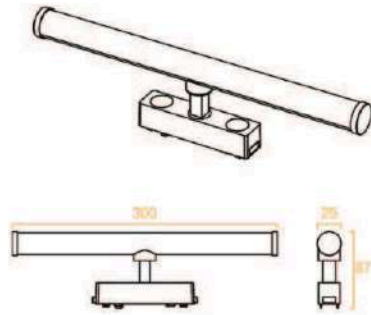

Product Code: MT26-SS300F
 Watt: 10W
 >CRI: Ra90
 Voltage: 48V
 Product Size: 300x25x87mm
 Color: Black / White
 Material: aluminum + plastic

CCT

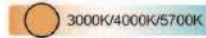

Beam angle



系统选配/System Options

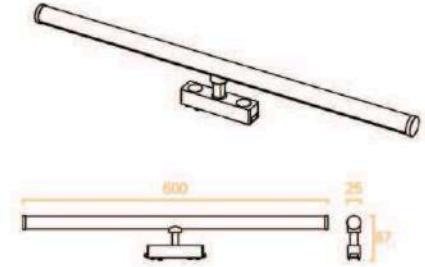

Product Code: MT26-SS600F
 Watt: 20W
 >CRI: Ra90
 Voltage: 48V
 Product Size: 600x25x87mm
 Color: Black / White
 Material: aluminum + plastic

CCT

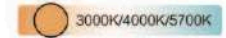

Beam angle



系统选配/System Options



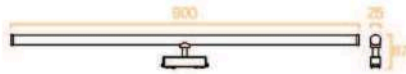
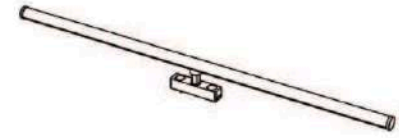
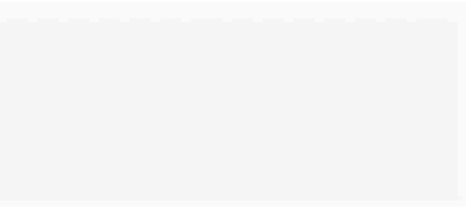

Product Code: MT26-SS900F
 Watt: 30W
 >CRI: Ra90
 Voltage: 48V
 Product Size: 900x25x87mm
 Color: Black / White
 Material: aluminum + plastic



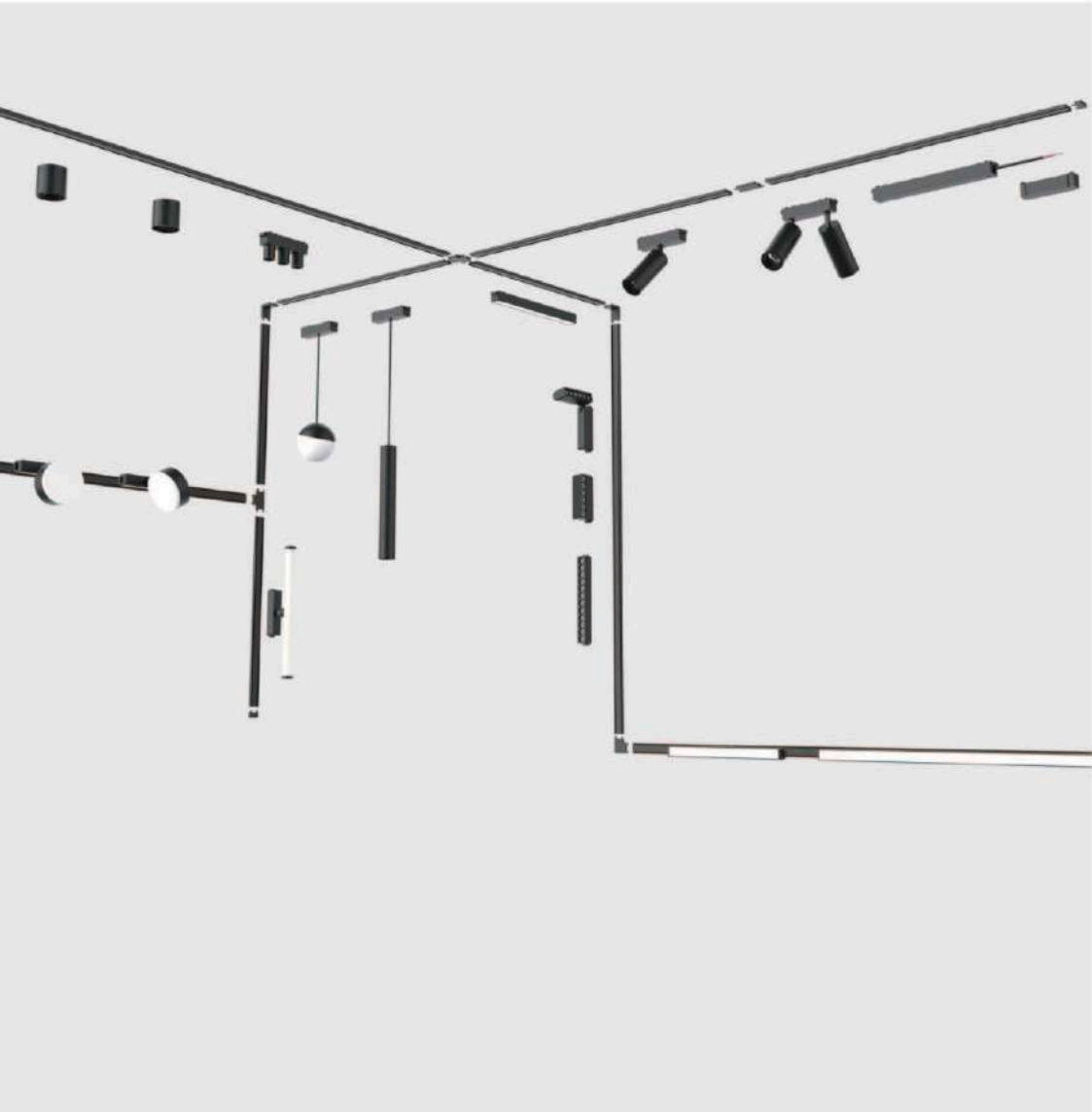

DC 48V

100W
200W

Product Code:
100W-Transformer
200W-Transformer



Product Code: Cable Box



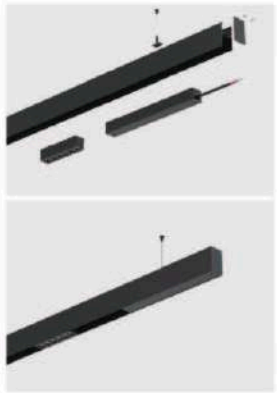
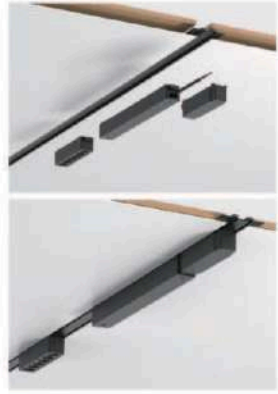

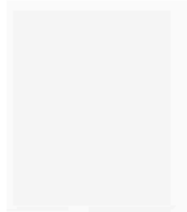
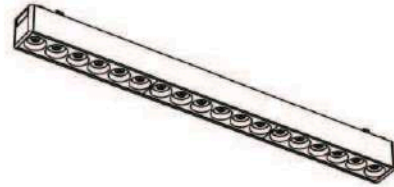
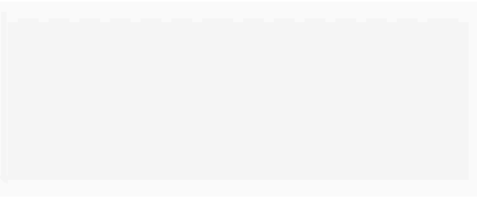

Product Code: MT26-18T
 Watt: 18W
 >CRI: Ra90
 Voltage: 48V
 Product Size: 338x26x24mm
 Color: Black / White
 Material: aluminum + plastic

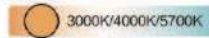
CCT

Beam angle

 24°

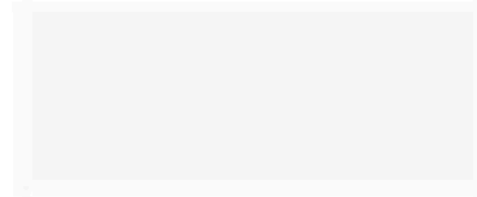
System Options

Product Code: MT26-24T
 Watt: 24W
 >CRI: Ra90
 Voltage: 48V
 Product Size: 445x26x24mm
 Color: Black / White
 Material: aluminum + plastic

CCT

Beam angle

 24°

System Options







Product Code: MT26-30T
Watt: 30W
>CRI: Ra90
Voltage: 48V
Product Size: 555x26x24mm
Color: Black / White
Material: aluminum + plastic

CCT
3000K/4000K/5700K

Beam angle
24°

System Options
ON-OFF 2.4GHz mijia ZigBee

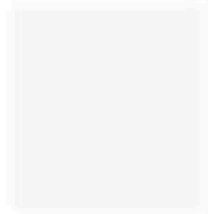
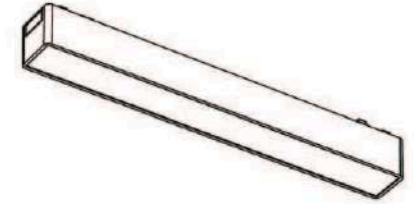
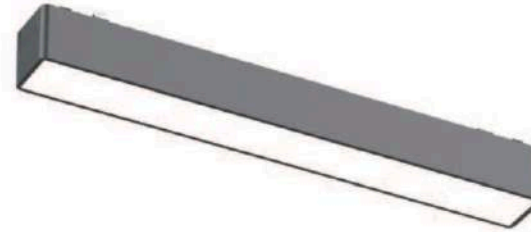
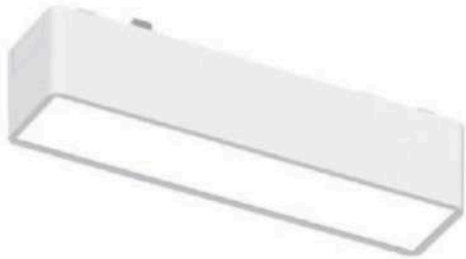
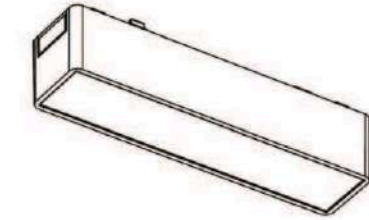
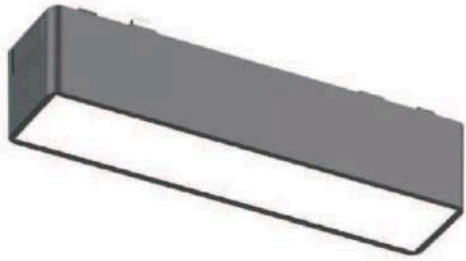



Product Code: MT26-6F
 Watt: 5W
 >CRI: Ra90
 Voltage: 48V
 Product Size: 122x26x24mm
 Color: Black / White
 Material: aluminum + plastic

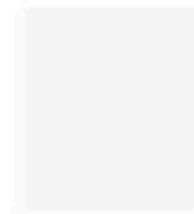

Product Code: MT26-12F
 Watt: 10W
 >CRI: Ra90
 Voltage: 48V
 Product Size: 230x26x24mm
 Color: Black / White
 Material: aluminum + plastic



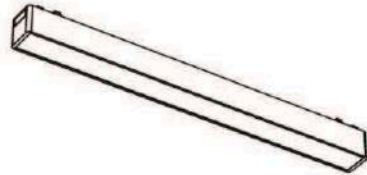
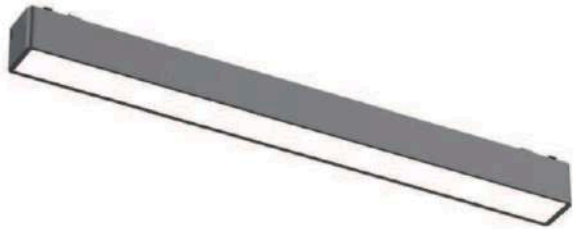

315

24

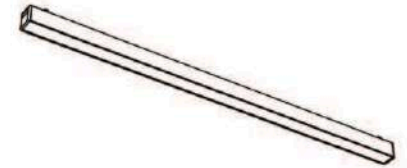
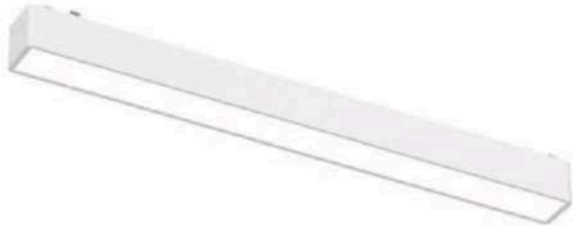

615

24

Product Code: MT26-300F
 Watt: 10W
 >CRI: Ra90
 Voltage: 48V
 Product Size: 315x25x24mm
 Color: Black / White
 Material: aluminum + plastic

CCT

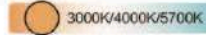

Beam angle



150°

System Options



Product Code: MT26-600F
 Watt: 20W
 >CRI: Ra90
 Voltage: 48V
 Product Size: 615x25x24mm
 Color: Black / White
 Material: aluminum + plastic

CCT

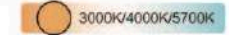

Beam angle



150°

System Options





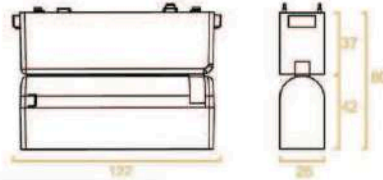
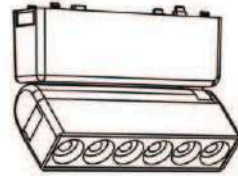

Product Code: MT26-ZD-6T
 Watt: 6W
 >CRI: Ra90
 Voltage: 48V
 Product Size: 122x25x80mm
 Color: Black / White
 Material: aluminum + plastic

CCT

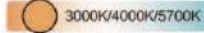

Beam angle



24°

System Options

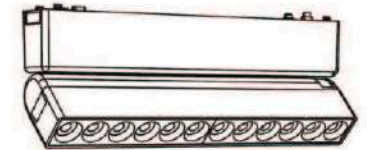

Product Code: MT26-ZD-12T
 Watt: 12W
 >CRI: Ra90
 Voltage: 48V
 Product Size: 230x25x80mm
 Color: Black / White
 Material: aluminum + plastic

CCT

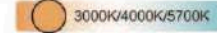

Beam angle



24°

System Options



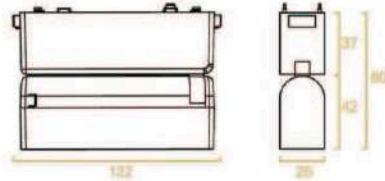
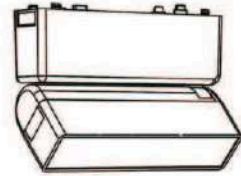

Product Code: MT26-ZD-6F
 Watt: 5W
 >CRI: Ra90
 Voltage: 48V
 Product Size: 122x26x80mm
 Color: Black / White
 Material: aluminum + plastic

CCT

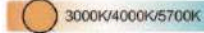

Beam angle



150°

System Options

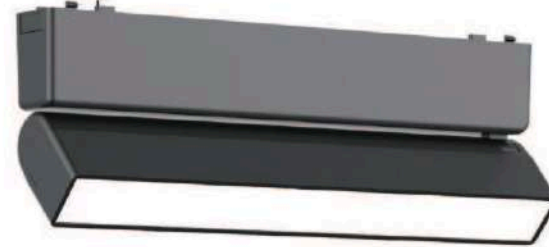

Product Code: MT26-ZD-12F
 Watt: 10W
 >CRI: Ra90
 Voltage: 48V
 Product Size: 230x26x80mm
 Color: Black / White
 Material: aluminum + plastic

CCT

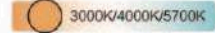

Beam angle



150°

System Options

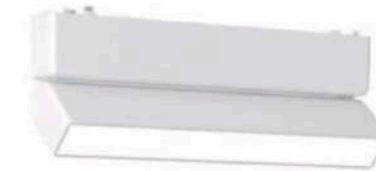



THANK YOU...

Thank you for exploring **Lumilife's** catalog of innovative lighting solutions. We are committed to illuminating your spaces with products that combine quality, efficiency, and style. Your trust and satisfaction inspire us to continue delivering excellence.

Let **Lumilife** brighten your world

**LUMILIFE LIGHTING & ELECTRICAL
LLC.** ALWAYS CHOOSE SMART
www.lumilife.ae

Office Address

1904,19TH Floor,
Palace Towers, Silicon Oasis,
Dubai, UAE.

Follow us On:



www.lumilife.ae



Info@lumilife.ae



[lumilife.ae](https://www.instagram.com/lumilife.ae)



[Lumilife lighting & Electrical LLC.](https://www.linkedin.com/company/lumilife-lighting-electrical-llc)

Our Other Services:

Home Automation | Electricals | Solar | ELV